

STAINLESS STEEL SUBMERSIBLE PUMPS

50HZ CATALOGUE

AN ISO 9001:2015 COMPANY, CE

پمپ های شناور تمام استیل
موتور های شناور تمام استیل

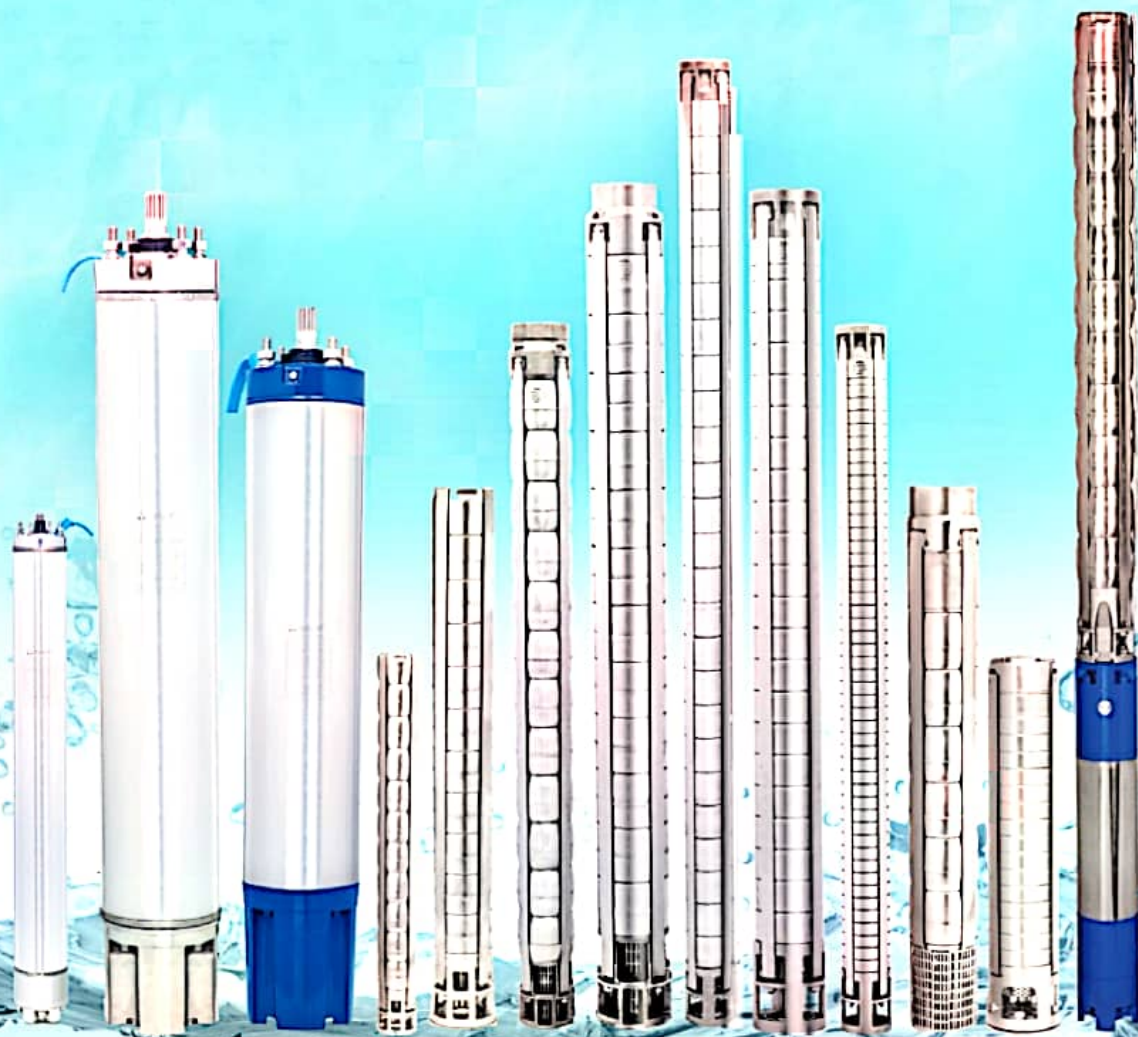

آدرس دفتر مرکزی: استان فارس - شهرستان لامرد - بلوار شهید مطهری - شرکت ایمن برق لامرد
تلفن: ۰۷۱-۵۲۷۳۰۳۳۳-۵۲۷۳۰۶۶۶-۰۷۱ همراه: ۰۹۱۷۷۸۲۲۱۰۷ www.waterjetpump.ir

آدرس دفتر فروش: شیراز - خیابان فردوسی - نرسیده به چهارراه هجرت - فروشگاه واترجت
تلفن: ۰۷۱-۳۲۲۲۶۱۱۰-۳۲۲۲۶۱۱۰ همراه: ۰۹۱۲۰۲۸۸۰۳۳

STAINLESS STEEL SUBMERSIBLE PUMPS

50Hz

PRODUCT ADVANTAGES AND SPECIFICATION

The specific feature of SS Submersible Pump is its high ratio of working pressure to delivery. Due to efficient design, these pumps have reduced stages resulting in longer pump life and trouble free operations.

SPECIFICATIONS & ADVANTAGES:

1. Suction, Stage Casing and Discharge Outlets are made of Stainless Steel.
2. Impellers are made of Stainless Steel.
3. Pump shaft is made of SS 431.
4. Bearing Bush for shaft is made of anti friction Rubber to provide wear resistance against sand.
5. Non Return Valve is made of Stainless Steel.
6. Cable Guard and Strainer are made of Stainless Steel.
7. Pump and Motor couplings are according to NEMA Standard.
8. Minimum Water on aspiration is one meter.
9. Maximum level of sand content: 50 gm/m³
10. Application : These pumps are for domestic, agriculture & industrial usage.
11. Operating Range - 4" - Head range : 9 mtr to 510 mtr

Flow rate : 7 lpm to 185 lpm

Immersion : 1 mtr minimum

6" - Head range : 4 mtr to 489 mtr

Flow rate : 70 lpm to 1300 lpm

Immersion : 1 mtr minimum

8" - Head range : 7 mtr to 395 mtr

Flow rate : 335 lpm to 2000 lpm

Immersion : 1 mtr minimum

10" - Head range : 3 mtr to 284 mtr

Flow rate : 1333 lpm to 3467 lpm

Immersion : 1 mtr minimum

*Performance tolerance can be +/- 7%

4VP 3 SERIES PUMP DESIGN

Material Specification

No.	PART NAME	MATERIAL
1	DISCHARGE CHAMBER HOUSING	STEEL CAST 304
2	VALVE CONE	S.S. 304
3.0	TOP BEARING + VALVE SEAT + GM BUSH	SUB ASSLY
3.1	VALVE SEAT	N.B.R. + S.S. 304
3.2	TOP BEARING HOUSING	STEEL CAST 304
3.3	TOP BEARING BUSH	GUN METAL
4	ALLEN BOLT M6X20	S.S. 304
5	TOP BUSH T-TYPE	S.S. 304
6	TOP DIFFUSER SLEEVE	S.S. 304
7	TOP DIFFUSER	S.S. 304
8	THRUST WASHER	S.S. 420
9	TOP SLEEVE	S.S. 304
10	MIDDLE BEARING SLEEVE_L-24	S.S. 304
11	MIDDLE BEARING SLEEVE_L-16	S.S. 304
12	MIDDLE BEARING ASSLY WITH BUSH	SUB ASSLY
13	DIFFUSER WITH BUSH	SUB ASSLY
14.0	DIFFUSER WITH BUSH & NECKRING ASSLY	SUB ASSLY
14.1	NECKRING	N.B.R. + S.S. 304
14.2	BEARING BUSH	N.B.R.
15	IMPELLER STAGE SLEEVE_L-19	S.S. 304
16	IMPELLER	S.S. 304
17	IMPELLER 1st STAGE SLEEVE_L-30.5	S.S. 304
18.0	SHAFTING WITH COUPLING	SUB ASSLY
18.1	PUMP SHAFT	S.S. 1.4362
18.2	COUPLING	S.S. 304
18.3	ALLEN BOLT M6 x 20	S.S. 304
19	1st DIFFUSER_21 MM	S.S. 304
20	SUCTION	STEEL CAST 304
21	CLAMPING STRIP	S.S. 304
22	WASHER	S.S. 304
23	HEX NUT M8	S.S. 316
24	CABLE GUARD	S.S. 304
25	CLAMP OF CABLE GUARD	S.S. 304
26	SCREW_M4	S.S. 304

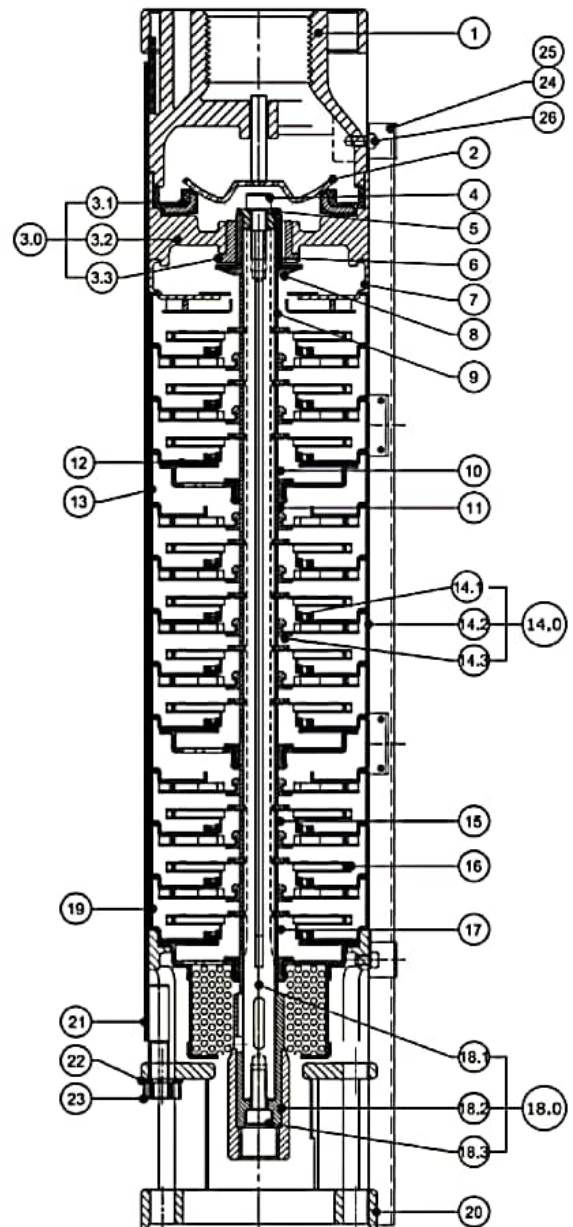

NOTE :
 PUMPS UP TO 33 STAGE DISCHARGE CHAMBER COMES WITH S.S. FABRICATED AND FROM 34 STAGE & ONWARDS WITH STEEL CAST .

4VP 3, 50Hz
ISO 9906 Annexure A

PERFORMANCE CURVES

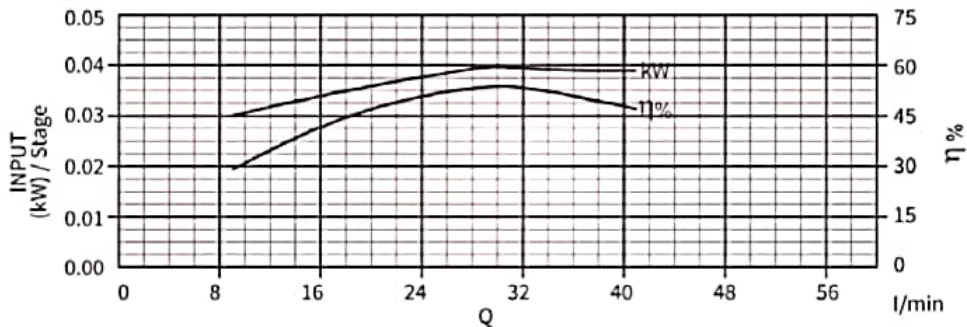
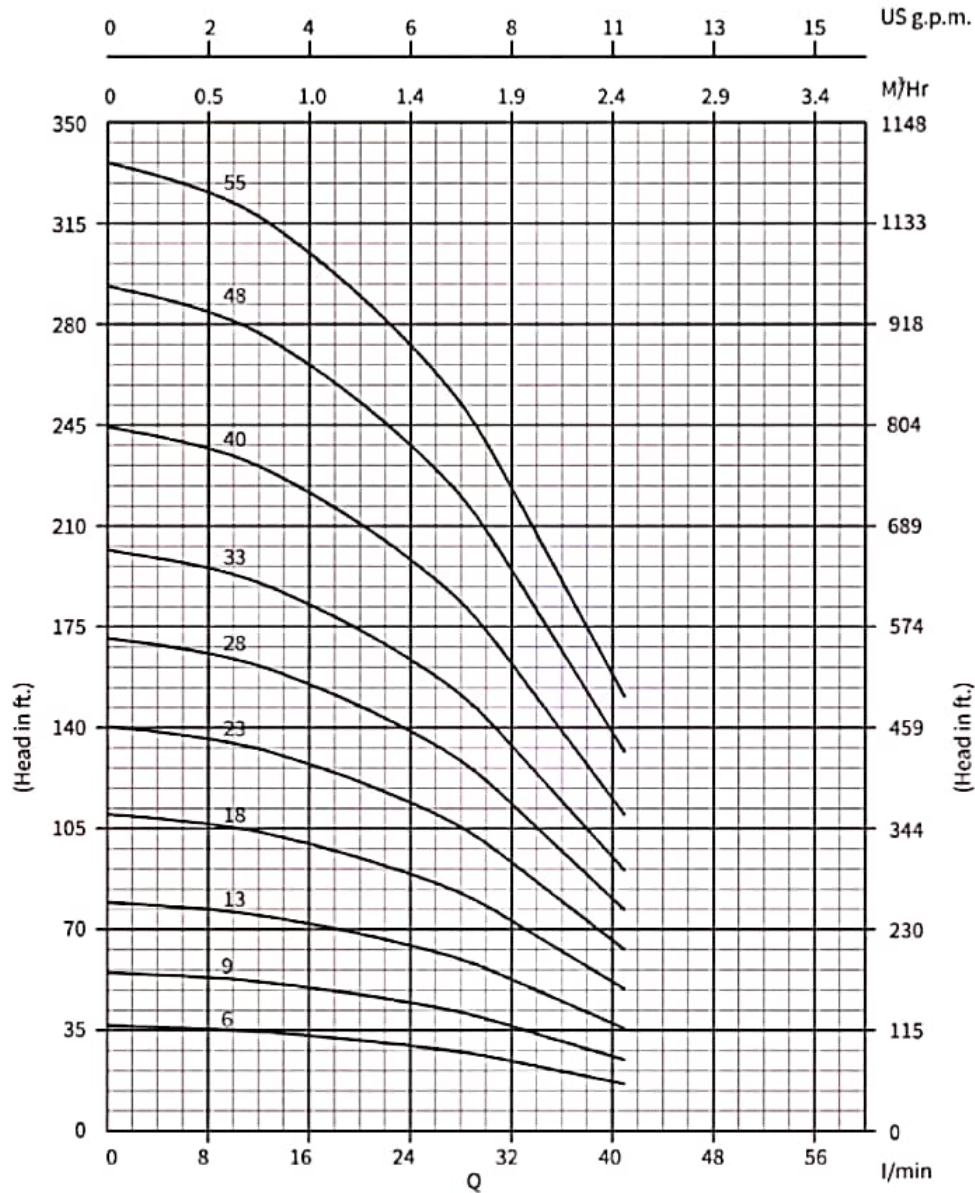

4VP 3, 50Hz
ISO 9906 Annexure A

PERFORMANCE CHART

Model Name		Stage	Rating		l/min m ³ /h	Discharge							
Single Phase	Three Phase		kW	HP		0	9	14	20	27	30	33	41
						0	0.54	0.84	1.20	1.62	1.80	1.98	2.46
4VP 3-06	4VP 3-06	6	0.37	0.50	HEAD IN Mtrs.	37	36	34	32	28	26	23	16
4VP 3-09	4VP 3-09	8	0.37	0.50		55	53	51	48	42	39	35	25
4VP 3-13	4VP 3-13	13	0.55	0.75		79	77	74	69	61	57	51	36
4VP 3-18	4VP 3-18	18	0.75	1.00		110	107	102	95	85	78	70	49
4VP 3-23	4VP 3-23	23	1.10	1.50		141	137	130	122	109	100	90	63
4VP 3-28	4VP 3-28	28	1.50	2.00		171	166	159	148	132	122	109	77
4VP 3-33	4VP 3-33	33	1.50	2.00		202	196	187	175	156	144	129	90
4VP 3-40	4VP 3-40	40	2.20	3.00		244	238	227	212	189	174	156	110
4VP 3-48	4VP 3-48	48	2.20	3.00		293	285	272	254	227	209	188	132
	4VP 3-55	55	3.00	4.00		336	327	312	291	260	240	215	151

Dimensions & Weights

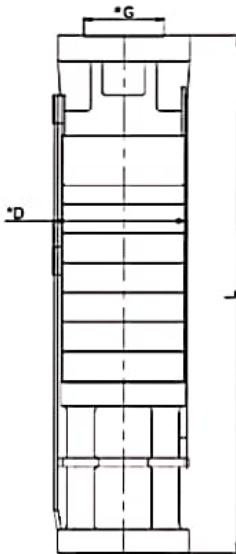

Model Name	Specification			
	D (mm)	L (mm)	Pump Weight Kg.	Weight (incl. pkg.) Kg.
4VP 3 - 06	98	282	3.2	3.5
4VP 3 - 09	98	345	4.2	4.7
4VP 3 - 13	98	429	5.4	6.1
4VP 3 - 18	98	534	7.2	8.1
4VP 3 - 23	98	660	8.9	10.1
4VP 3 - 28	98	765	10.6	12.0
4VP 3 - 33	98	870	12.2	13.9
4VP 3 - 40	98	1094	13.0	14.8
4VP 3 - 48	98	1283	14.6	16.5
4VP 3 - 55	98	1430	16.2	18.4

*G: Available Outlet Size 1.25" BSP
*D: With Cable Guard

4VP 4 SERIES PUMP DESIGN

Material Specification

No.	PART NAME	MATERIAL
1	DISCHARGE CHAMBER HOUSING	STEEL CAST 304
2	VALVE CONE	S.S. 304
3.0	TOP BEARING + VALVE SEAT + GM BUSH	SUB ASSLY
3.1	VALVE SEAT	N.B.R. + S.S. 304
3.2	TOP BEARING HOUSING	STEEL CAST 304
3.3	TOP BEARING BUSH	GUN METAL
4	ALLEN BOLT M6X20	S.S. 304
5	TOP BUSH T-TYPE	S.S. 304
6	TOP DIFFUSER SLEEVE	S.S. 304
7	TOP DIFFUSER	S.S. 304
8	THRUST WASHER	S.S. 420
9	TOP SLEEVE	S.S. 304
10	MIDDLE BEARING SLEEVE_L-24	S.S. 304
11	MIDDLE BEARING SLEEVE_L-16	S.S. 304
12	MIDDLE BEARING ASSLY WITH BUSH	SUB ASSLY
13	DIFFUSER WITH BUSH	SUB ASSLY
14.0	DIFFUSER WITH BUSH & NECKRING ASSLY	SUB ASSLY
14.1	NECKRING	N.B.R. + S.S. 304
14.2	BEARING BUSH	N.B.R.
15	IMPELLER STAGE SLEEVE_L-19	S.S. 304
16	IMPELLER	S.S. 304
17	IMPELLER 1st STAGE SLEEVE_L-30.5	S.S. 304
18.0	SHAFTING WITH COUPLING	SUB ASSLY
18.1	PUMP SHAFT	S.S. 1.4362
18.2	COUPLING	S.S. 304
18.3	ALLEN BOLT M6 x 20	S.S. 304
19	1st DIFFUSER_21 MM	S.S. 304
20	SUCTION	STEEL CAST 304
21	CLAMPING STRIP	S.S. 304
22	WASHER	S.S. 304
23	HEX NUT M8	S.S. 316
24	CABLE GUARD	S.S. 304
25	CLAMP OF CABLE GUARD	S.S. 304
26	SCREW_M4	S.S. 304

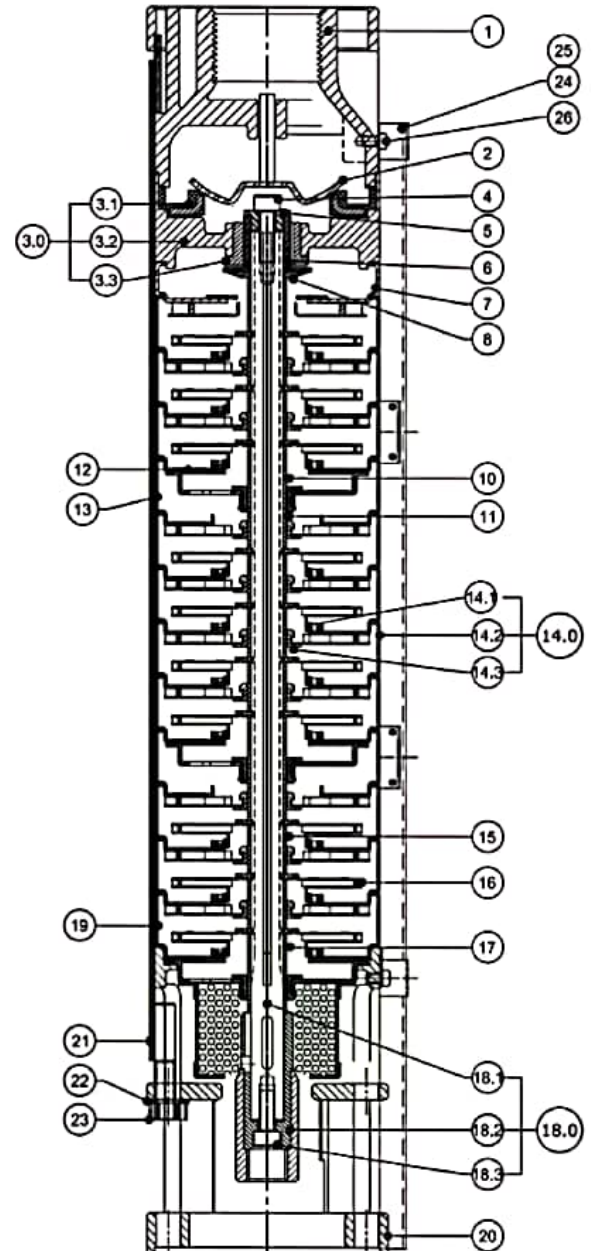

NOTE :
PUMPS UP TO 33 STAGE DISCHARGE CHAMBER COMES WITH S.S. FABRICATED AND FROM 34 STAGE & ONWARDS WITH STEEL CAST .

4VP 4, 50Hz
 ISO 9906 Annexure A

PERFORMANCE CURVES

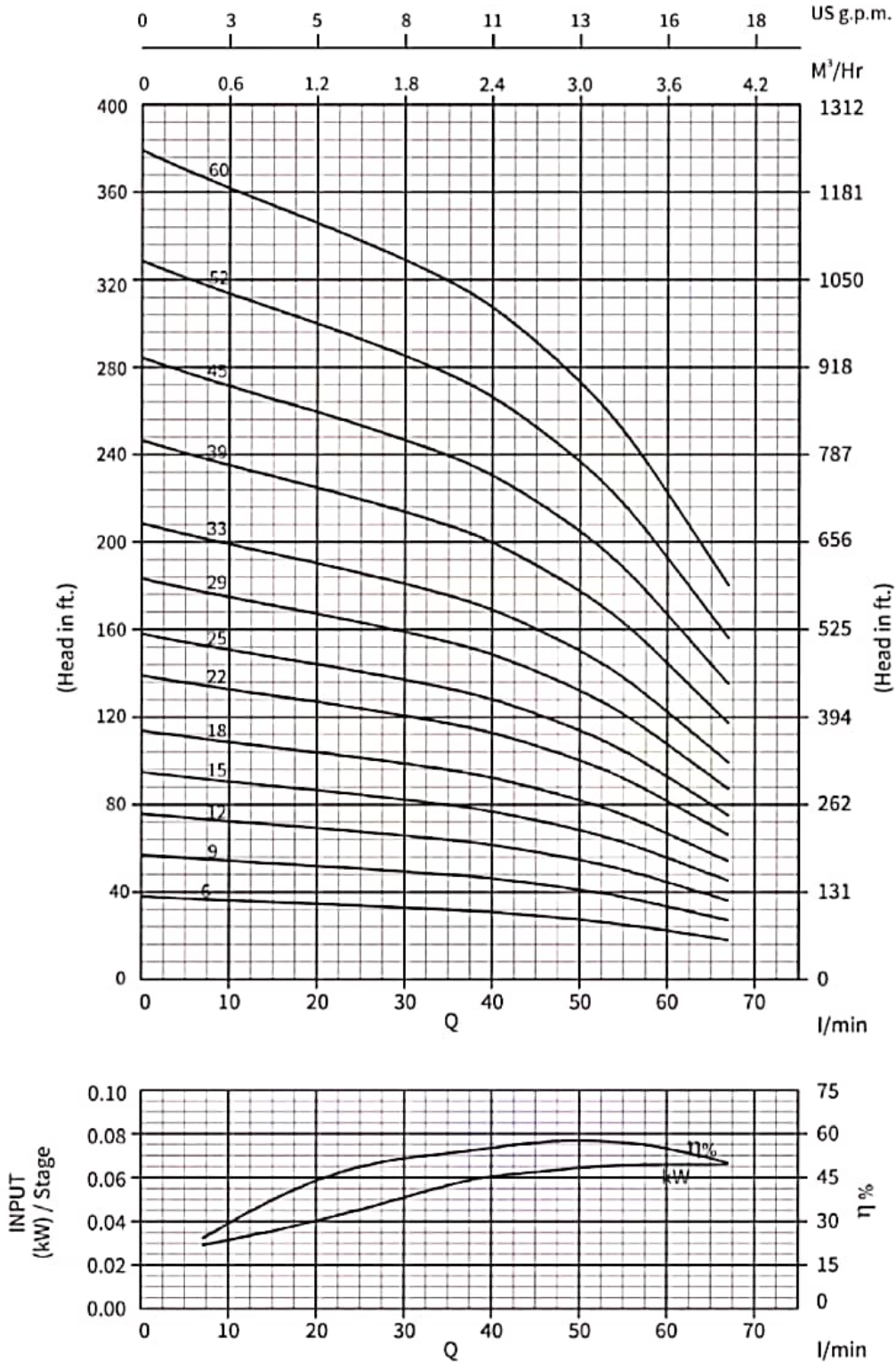

4VP 4, 50Hz
ISO 9906 Annexure A

PERFORMANCE CHART

Model Name		Rating			Discharge									
Single Phase	Three Phase	Stage	kW	HP	l/min	0	7	20	34	40	47	54	60	67
					m ³ /h	0	0.42	1.20	2.04	2.40	2.82	3.24	3.60	4.02
4VP 4-06	4VP 4-06	06	0.37	0.50	38	37	35	32	31	28	26	22	18	
4VP 4-09	4VP 4-09	09	0.55	0.75	57	55	52	48	46	43	39	33	17	
4VP 4-12	4VP 4-12	12	0.75	1.00	76	73	69	64	62	57	52	45	36	
4VP 4-15	4VP 4-15	15	1.10	1.50	95	92	87	81	77	71	64	56	45	
4VP 4-18	4VP 4-18	18	1.10	1.50	114	110	104	97	93	86	77	67	54	
4VP 4-22	4VP 4-22	22	1.50	2.00	139	134	127	118	113	104	95	82	66	
4VP 4-25	4VP 4-25	25	1.50	2.00	158	152	144	134	128	119	108	93	75	
4VP 4-29	4VP 4-29	29	2.20	3.00	183	177	168	156	149	138	125	108	87	
4VP 4-33	4VP 4-33	33	2.20	3.00	209	201	191	177	170	157	142	122	99	
	4VP 4-39	39	3.00	4.00	246	238	225	209	200	185	168	145	117	
	4VP 4-45	45	3.00	4.00	284	274	260	242	231	214	194	167	135	
	4VP 4-52	52	4.00	5.50	329	317	301	279	267	247	224	193	156	
	4VP 4-60	60	4.00	5.50	379	366	347	322	308	285	258	223	180	

Dimensions & Weights

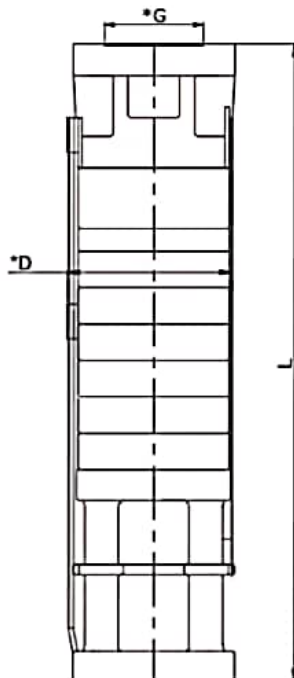

Model Name	Specification			
	D (mm)	L (mm)	Pump Weight Kg.	Weight (incl. pkg.) Kg.
4VP 4 - 06	98	282	3.4	3.7
4VP 4 - 09	98	345	4.4	4.9
4VP 4 - 12	98	408	5.4	6.0
4VP 4 - 15	98	471	6.4	7.2
4VP 4 - 18	98	534	7.4	8.3
4VP 4 - 22	98	639	8.7	9.8
4VP 4 - 25	98	702	9.7	11.0
4VP 4 - 29	98	786	10.9	12.4
4VP 4 - 33	98	870	12.2	13.9
4VP 4 - 39	98	1073	12.7	14.5
4VP 4 - 45	98	1220	14.0	16.0
4VP 4 - 52	98	1367	15.5	17.8
4VP 4 - 60	98	1535	17.3	20.0

*G: Available Outlet Size 1.25" BSP

*D: With Cable Guard

4VP 6 SERIES PUMP DESIGN

Material Specification

No.	PART NAME	MATERIAL
1	DISCHARGE CHAMBER HOUSING	STEEL CAST 304
2	VALVE CONE	S.S. 304
3.0	TOP BEARING + VALVE SEAT + GM BUSH	SUB ASSLY
3.1	VALVE SEAT	N.B.R. + S.S. 304
3.2	TOP BEARING HOUSING	STEEL CAST 304
3.3	TOP BEARING BUSH	GUN METAL
4	ALLEN BOLT M6X20	S.S. 304
5	TOP BUSH T-TYPE	S.S. 304
6	TOP DIFFUSER SLEEVE	S.S. 304
7	TOP DIFFUSER	S.S. 304
8	THRUST WASHER	S.S. 420
9	TOP & IMPELLER STAGE SLEEVE_L-22	S.S. 304
10	IMPELLER	S.S. 304
11	MIDDLE BEARING SLEEVE_L-24	S.S. 304
12	MIDDLE BEARING ASSLY WITH BUSH	SUB ASSLY
13	DIFFUSER WITH BUSH	SUB ASSLY
14.0	DIFFUSER WITH BUSH & NECKRING ASSLY	SUB ASSLY
14.1	NECKRING	N.B.R. + S.S. 304
14.2	DIFFUSER	S.S. 304
14.3	BEARING BUSH	N.B.R.
15	IMPELLER 1st STAGE SLEEVE_L-32	S.S. 304
16	1st DIFFUSER_24 MM	S.S. 304
17.0	SHAFTING WITH COUPLING	SUB-ASSLY
17.1	PUMP SHAFT	S.S. 1.4362
17.2	COUPLING	S.S. 304
17.3	ALLEN BOLT M6 x 20	S.S. 304
18	SUCTION	STEEL CAST 304
19	CLAMPING STRIP	S.S. 304
20	WASHER	S.S. 304
21	HEX NUT M8	S.S. 316
22	CABLE GUARD	S.S. 304
23	CLAMP OF CABLE GUARD	S.S. 304
24	SCREW_M4	S.S. 304

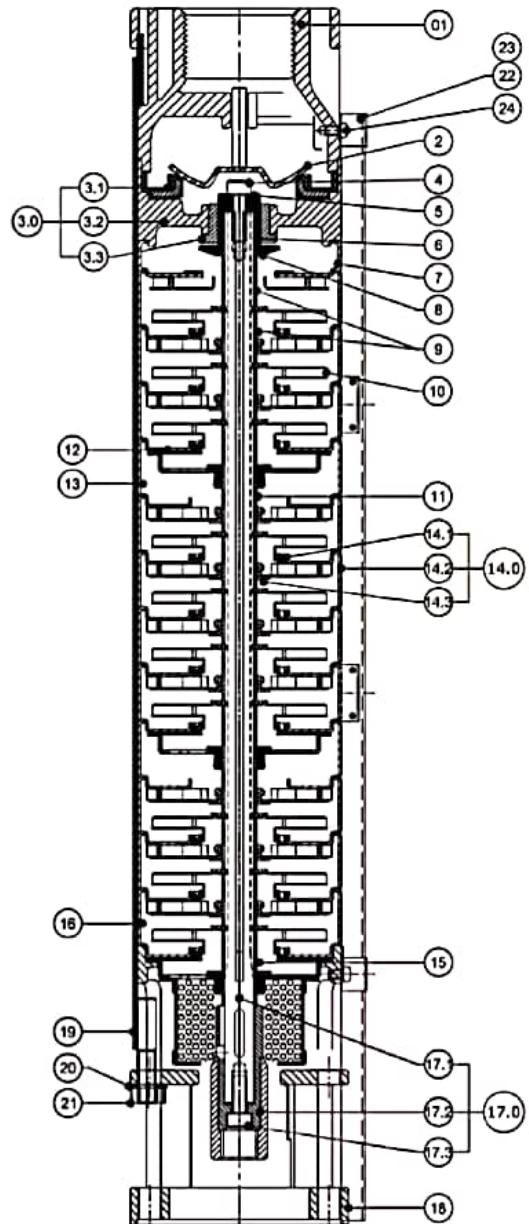

NOTE :

PUMPS UP TO 33 STAGE DISCHARGE CHAMBER COMES WITH S.S. FABRICATED AND FROM 34 STAGE & ONWARDS WITH STEEL CAST .

4VP 6, 50Hz
ISO 9906 Annexure A

PERFORMANCE CURVES

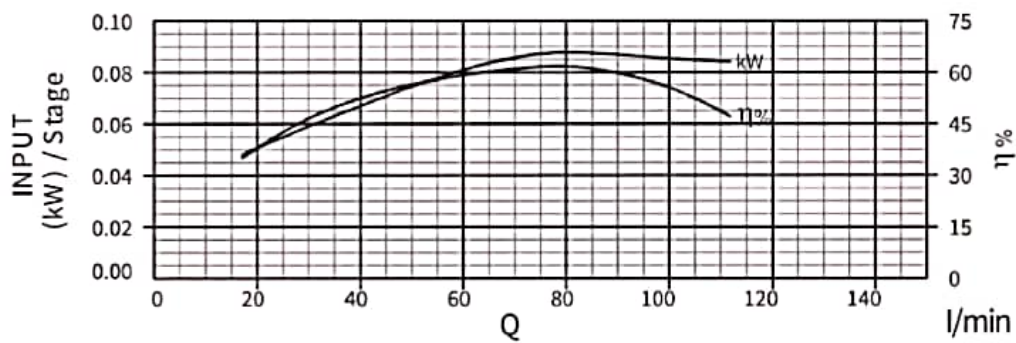
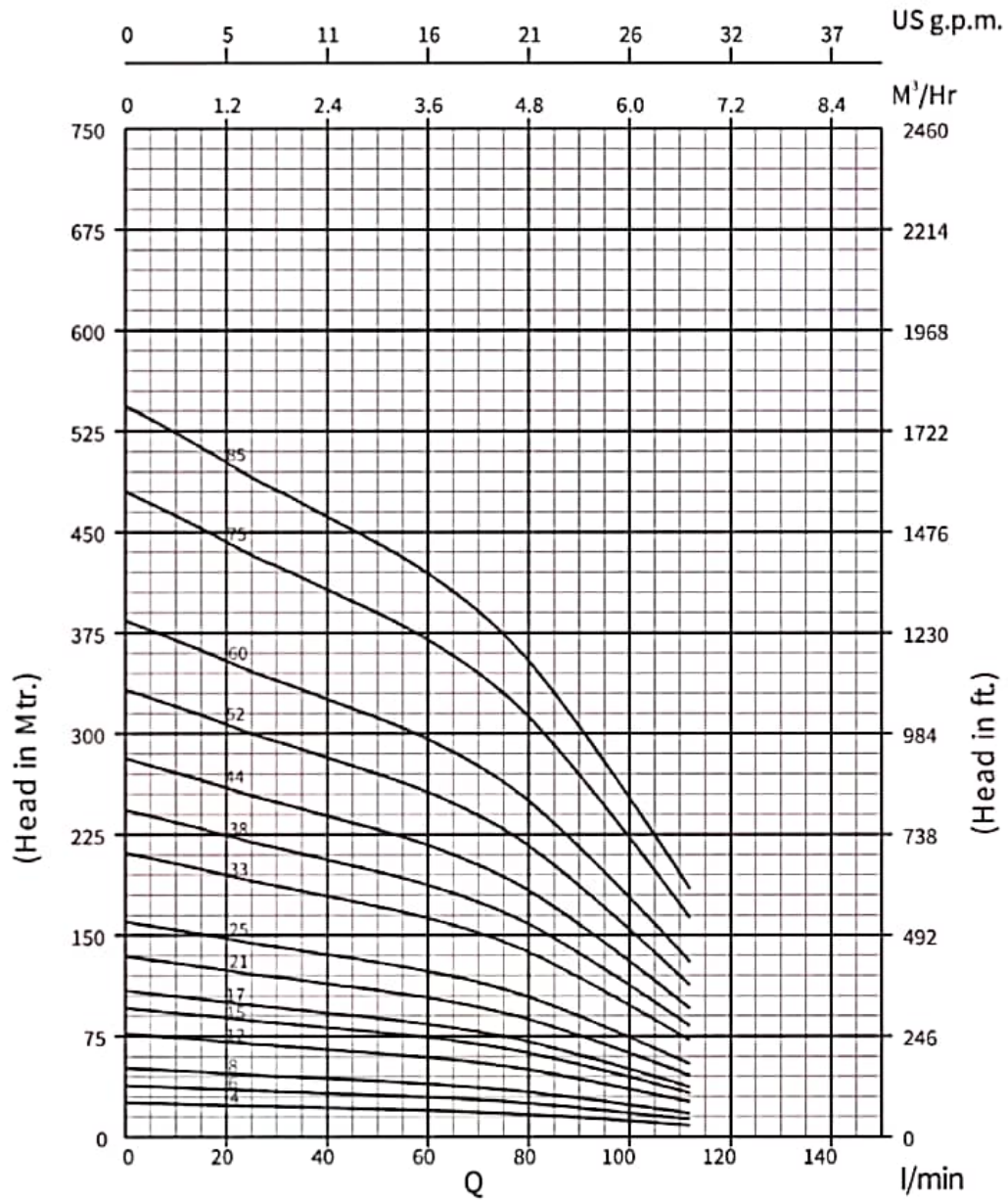

4VP 6, 50Hz
ISO 9906 Annexure A

PERFORMANCE CHART

Model Name		Stage	Rating		l/min m ³ /h	Discharge										
Single Phase	Three Phase		kW	HP		0	17	25	31	40	57	74	84	101	112	

4VP 6-04	4VP 6-04	4	0.37	0.50	HEAD IN Mtrs.	26	24	23	22.5	22	20	18	16	12	9	
4VP 6-06	4VP 6-06	6	0.55	0.75		38	36	34.5	34	33	30	27	24	18	13	
4VP 6-08	4VP 6-08	8	0.75	1.00		51	48	46	45	43	40	36	32	23	17	
4VP 6-12	4VP 6-12	12	1.10	1.50		77	72	69	68	65	61	54	48	35	26	
4VP 6-15	4VP 6-15	15	1.50	2.00		96	90	86	85	81	76	67	60	44	33	
4VP 6-17	4VP 6-17	17	1.50	2.00		109	102	98	96	92	86	76	67	50	37	
4VP 6-21	4VP 6-21	21	2.20	3.00		134	126	121	119	114	106	94	83	61	46	
4VP 6-25	4VP 6-25	25	2.20	3.00		160	150	144	141	136	126	112	99	73	54	
	4VP 6-33	33	3.00	4.00		211	198	190	186	179	167	148	131	96	72	
	4VP 6-38	38	4.00	5.50		243	228	218	215	206	192	170	151	111	82	
	4VP 6-44	44	4.00	5.50		282	264	253	249	238	222	197	175	128	95	
	4VP 6-52	52	5.50	7.50		333	312	299	294	282	263	233	206	152	113	
	4VP 6-60	60	5.50	7.50		384	360	345	339	325	303	269	238	175	130	
	4VP 6-75	75	7.50	10.00		480	450	431	424	406	379	336	298	219	163	
	4VP 6-85	85	7.50	10.00		544	510	489	480	461	429	381	337	248	184	

Dimensions & Weights

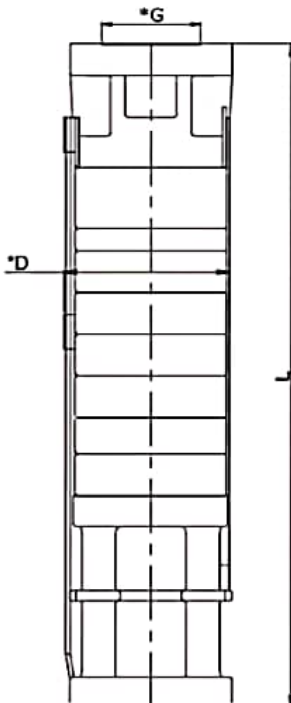

Model Name	Specification			
	*D (mm)	L (mm)	Pump Weight Kg.	Weight (incl. pkg.) Kg.
4VP 6 - 04	98	252	3.5	3.7
4VP 6 - 06	98	300	3.9	4.2
4VP 6 - 08	98	348	4.2	4.6
4VP 6 - 12	98	444	6.2	6.8
4VP 6 - 15	98	516	6.9	7.7
4VP 6 - 17	98	564	7.3	8.1
4VP 6 - 21	98	684	8.8	9.9
4VP 6 - 25	98	780	10.2	11.5
4VP 6 - 33	98	972	13.1	14.8
4VP 6 - 38	98	1169	13.9	15.8
4VP 6 - 44	98	1337	15.0	17.2
4VP 6 - 52	98	1529	18.0	20.6
4VP 6 - 60	98	1721	20.0	23.0
4VP 6 - 52	138	1546	20.2	22.2
4VP 6 - 60	138	1738	22.7	25.0
4VP 6 - 75	138	2122	27.7	30.5
4VP 6 - 85	138	2386	31.0	36.5

*G: Available Outlet Size 1.5" BSP

*D: With Cable Guard

4VP 6-52, 4VP 6-60, 4VP 6-75 & 4VP 6-85 Pump Available in 6" Joining.

4VP 9 SERIES PUMP DESIGN

Material Specification

No.	PART NAME	MATERIAL
1	DISCHARGE CHAMBER HOUSING	STEEL CAST 304
2	VALVE CONE	S.S. 304
3.0	TOP BEARING + VALVE SEAT + GM BUSH	SUB ASSLY
3.1	VALVE SEAT	N.B.R.
3.2	TOP BEARING HOUSING	STEEL CAST 304
3.3	TOP GM BUSH	GUN METAL
4	TOP DIFFUSER	S.S. 304
5	SPACING WASHER	PTFE
6.0	DIFFUSER ASSLY	SUB ASSLY
6.1	NECK RING	N.B.R. + S.S. 304
6.2	DIFFUSER	S.S. 304
6.3	BEARING BUSH	N.B.R.
7.0	IMPELLER ASSLY	SUB ASSLY
7.1	COLLET NUT	S.S. 304
7.2	IMPELLER	S.S. 304
7.3	COLLET	S.S. 304
8	DIFFUSER 1st	S.S. 304
9.0	SHAFTING WITH COUPLING	SUB ASSLY
9.1	PUMP SHAFT	S.S. 431
9.2	COUPLING	S.S. 304
9.3	ALLEN BOLT	S.S. 304
10	STRAINER	S.S. 304
11	SUCTION	STEEL CAST 304
12	CLAMPING STRIP	S.S. 304
13	WASHER	S.S. 304
14	HEX NUT	S.S. 316
15	CABLE GUARD	S.S. 304
16	CLAMP OF CABLE GUARD	S.S. 304
17	SCREW_M4	S.S. 304

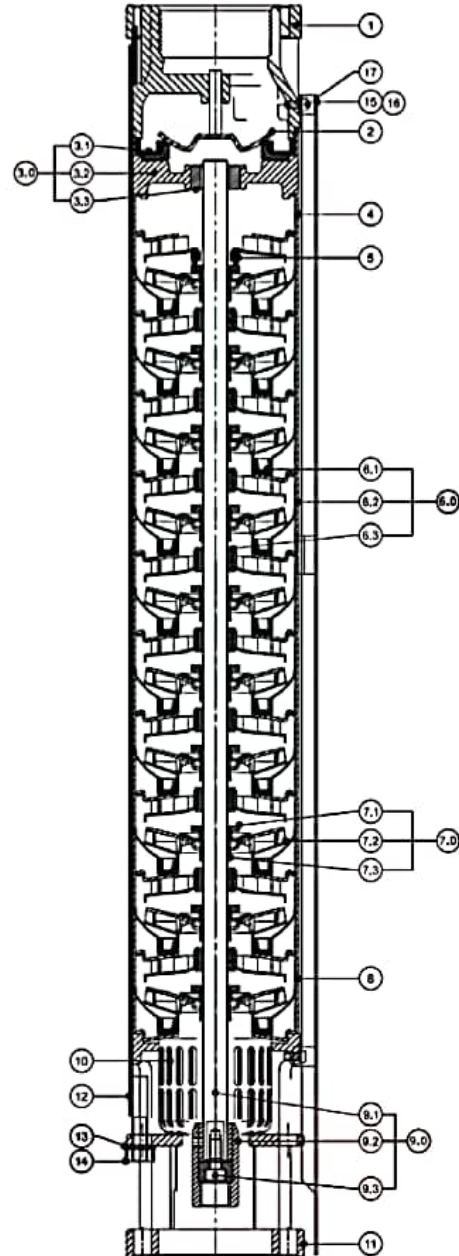

4VP 9, 50Hz
ISO 9906 Annexure A

PERFORMANCE CURVES

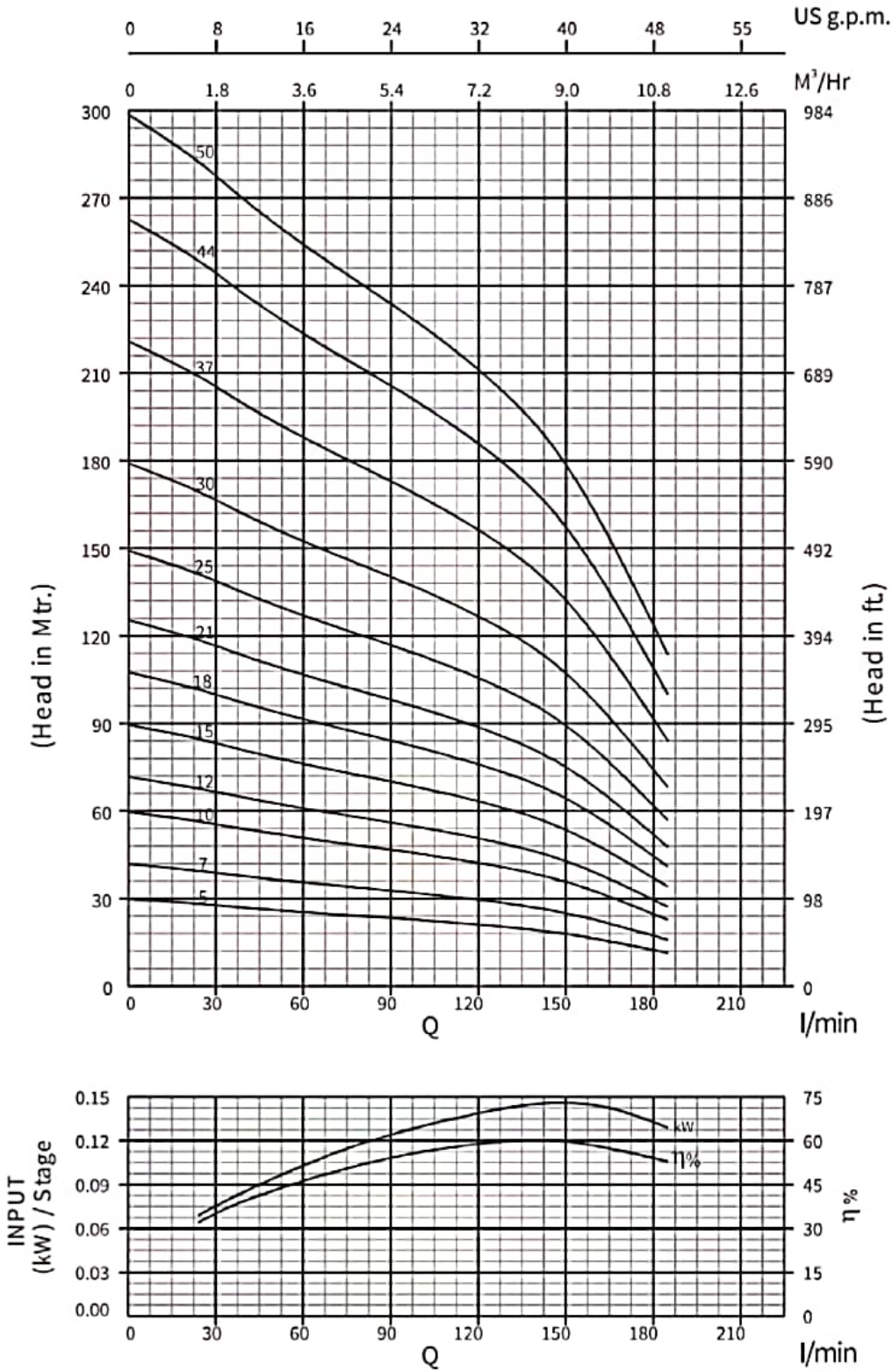

4VP 9, 50Hz
ISO 9906 Annexure A

PERFORMANCE CHART

Model Name		Rating			Discharge									
Single Phase	Three Phase	Stage	kW	HP	l/min	0	24	34	67	101	134	151	168	185
					m ³ /h	0	1.44	2.0	4.0	6.0	8.0	9.0	10.0	11.1
4VP 9-05	4VP 9-05	5	0.75	1.00	HEAD IN Mtrs.	30	28	27	25	23	20	18	15	11
4VP 9-07	4VP 9-07	7	1.10	1.50		42	40	38	35	32	28	25	21	16
4VP 9-10	4VP 9-10	10	1.50	2.00		60	57	55	50	45	40	36	30	23
4VP 9-12	4VP 9-12	12	2.20	3.00		72	68	66	60	54	48	43	36	27
4VP 9-15	4VP 9-15	15	2.20	3.00		90	85	82	75	68	60	54	45	34
	4VP 9-18	18	3.00	4.00		107	102	98	89	82	72	64	53	41
	4VP 9-21	21	4.00	5.50		125	119	115	104	95	84	75	62	48
	4VP 9-25	25	4.00	5.50		149	142	136	124	114	100	89	74	57
	4VP 9-30	30	5.50	7.50		179	170	164	149	136	120	107	89	68
	4VP 9-37	37	5.50	7.50		221	210	202	184	168	148	132	110	84
	4VP 9-44	44	7.50	10.00		263	249	240	219	200	176	157	131	100
	4VP 9-50	50	7.50	10.00		298	284	273	248	227	200	178	148	114

Dimensions & Weights

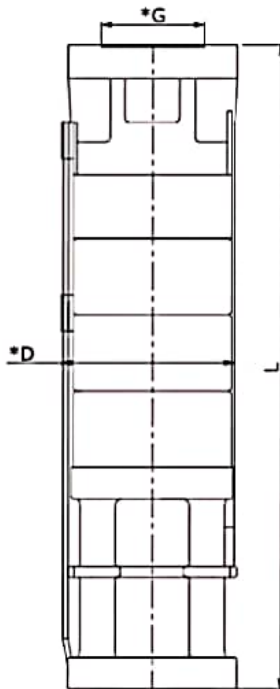

Model Name	Specification			
	*D (mm)	L (mm)	Pump Weight Kg.	Weight (incl. pkg.) Kg.
4VP 9 - 05	98	451	6.60	7.3
4VP 9 - 07	98	535	7.50	8.3
4VP 9 - 10	98	661	8.80	9.7
4VP 9 - 12	98	745	9.70	10.7
4VP 9 - 15	98	871	11.00	12.1
4VP 9 - 18	98	997	12.30	13.5
4VP 9 - 21	98	1123	13.60	15.0
4VP 9 - 25	98	1291	15.40	16.9
4VP 9 - 30	98	1501	17.60	19.4
4VP 9 - 37	98	1795	20.70	22.8
4VP 9 - 44	98	2089	24.30	26.7
4VP 9 - 50	98	2341	27.10	29.8
4VP 9 - 30	138	1518	19.60	21.6
4VP 9 - 37	138	1812	22.90	25.2
4VP 9 - 44	138	2106	25.80	28.4
4VP 9 - 50	138	2358	29.60	32.6
4VP 9 - 58	138	2694	31.40	34.5

*G: Available Outlet Size BSP 2.0"

* D: With Cable Guard

4VP 9-30, 4VP 9-37, 4 VP 9-44, 4VP 9-50 & 4VP 9-58 pump are also available in 6" Joining.

4VP 14 SERIES PUMP DESIGN

Material Specification

No.	PART NAME	MATERIAL
1	DISCHARGE CHAMBER HOUSING	STEEL CAST 304
2	VALVE CONE	S.S. 304
3	SPACING WASER	PTFE
4.0	DIFFUSER ASSLY	SUB ASSLY
4.1	NECKRING	N.B.R. + NYLON
4.2	BEARING BUSH	N.B.R
4.3	DIFFUSER	S.S. 304
5.0	IMPELLER	S.S. 304
5.1	NOT OF COLLET	S.S. 304
5.2	IMPELLER	S.S. 304
5.3	COLLET	S.S. 304
6.0	PUMP SHAFT & COUPLING	SUB ASSLY
6.1	PUMP SHAFT	S.S. 1.4362
6.2	COUPLING	S.S. 304
7	S.S.CONNECTOR	S.S. 304
8	STRAINER	S.S. 304
9	SUCTION	STEEL CAST 304
10	CLAMPING STRIP	S.S. 304
11	WASHER	S.S. 304
12	HEX NUT	S.S. 316
13	CABLE GUARD	S.S. 304
14	CLAMP OF CABLE GUARD	S.S. 304
15	SCREW_M4	S.S. 304

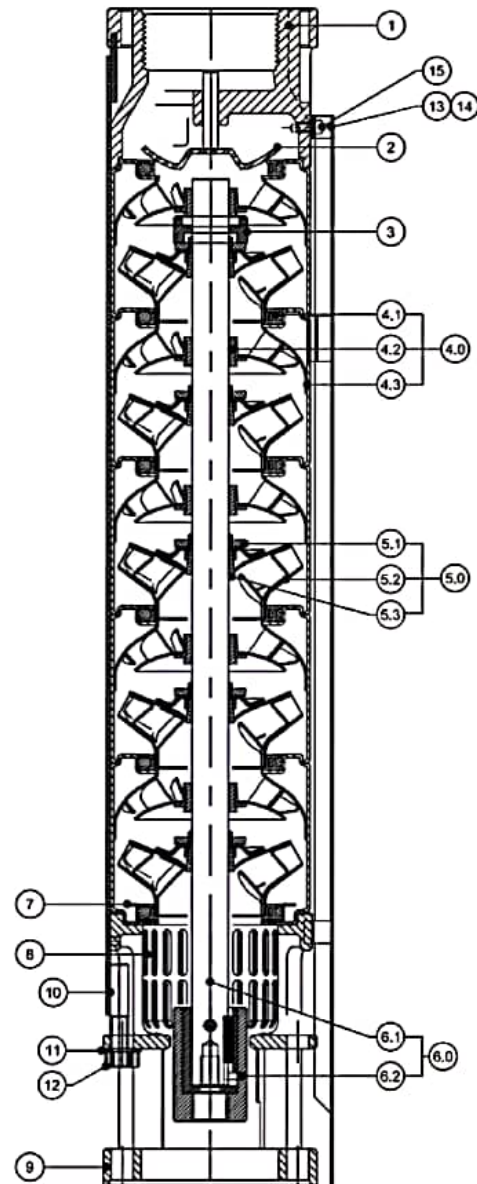

4VP 14, 50Hz
ISO 9906 Annexure A

PERFORMANCE CURVES

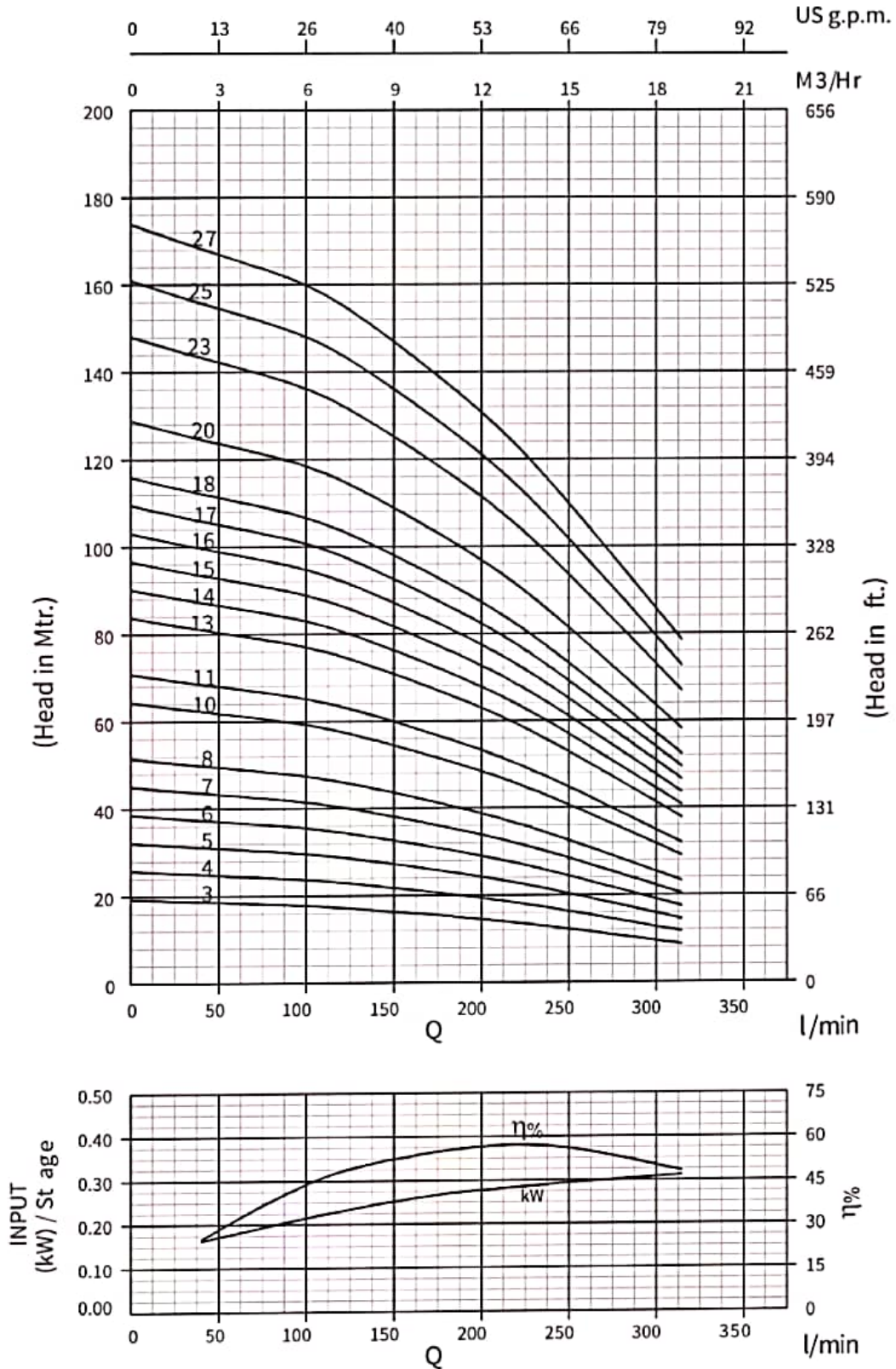

4VP 14, 50Hz
ISO 9906 Annexure A

PERFORMANCE CHART

Model Name		Stage	Rating		Discharge							
Single Phase	Three Phase		kW	HP	l/min m ³ /h	0	40	95	130	170	215	260

Model Name	Model Name	Stage	kW	HP	HEAD IN Mtrs.	19	18.5	18	17	16	14	12	9
4VP 14-03	4VP 14-03	03	1.10	1.50		19	18.5	18	17	16	14	12	9
4VP 14-04	4VP 14-04	04	1.10	1.50		26	25	24	23	21	19	16	12
4VP 14-05	4VP 14-05	05	1.50	2.00		32	31	30	28	26	23	20	14
4VP 14-06	4VP 14-06	06	1.50	2.00		39	37	36	34	31	28	23	17
4VP 14-07	4VP 14-07	07	2.20	3.00		45	44	42	40	37	33	27	20
4VP 14-08	4VP 14-08	08	2.20	3.00		52	50	48	45	42	37	31	23
	4VP 14-10	10	3.00	4.00		64	62	60	57	52	47	39	29
	4VP 14-11	11	3.00	4.00		71	68	66	62	57	51	43	32
	4VP 14-13	13	3.00	4.00		84	81	78	74	68	61	51	38
	4VP 14-14	14	4.00	5.50		90	87	84	79	73	65	55	41
	4VP 14-15	15	4.00	5.50		97	93	90	85	78	70	58	44
	4VP 14-16	16	4.00	5.50		103	100	96	91	84	75	62	46
	4VP 14-17	17	4.00	5.50		109	106	102	96	89	79	66	49
	4VP 14-18	18	5.50	7.50		116	112	108	102	94	84	70	52
	4VP 14-20	20	5.50	7.50		129	124	120	113	104	93	78	58
	4VP 14-23	23	5.50	7.50		148	143	138	130	120	107	90	67
	4VP 14-25	25	7.50	10.00		161	156	150	142	130	117	98	72
	4VP 14-27	27	7.50	10.00		174	168	162	153	141	126	105	78

Dimensions & Weights

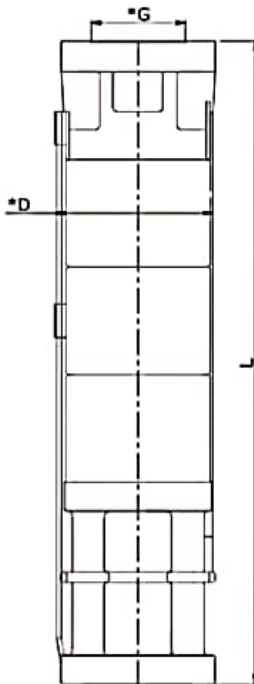

Model Name	Specification			
	*D (mm)	L (mm)	Pump Weight Kg.	Weight (incl.pkg.) Kg.
4VP 14 - 03	98	387	4.70	5.4
4VP 14 - 04	98	452	5.40	6.2
4VP 14 - 05	98	517	6.10	7.0
4VP 14 - 06	98	582	6.9	7.9
4VP 14 - 07	98	647	7.7	8.9
4VP 14 - 08	98	712	8.4	9.7
4VP 14 - 10	98	842	9.9	11.4
4VP 14 - 11	98	907	10.6	12.2
4VP 14 - 13	98	1037	12.1	13.9
4VP 14 - 14	98	1102	12.9	14.8
4VP 14 - 15	98	1167	13.6	15.6
4VP 14 - 16	98	1232	14.4	16.6
4VP 14 - 17	98	1297	15.1	17.4
4VP 14 - 18	98	1362	16.6	19.1
4VP 14 - 20	98	1492	18.1	20.8
4VP 14 - 23	98	1687	20.4	23.5
4VP 14 - 25	98	1817	21.9	25.2
4VP 14 - 27	98	1947	23.4	26.9

G: Available Outlet Size 2.0" BSP

D: With Cable Guard

4VP 14-18, 4VP 14-25, & 4VP 14-27

pump are also available in 6" Joining.

6VP 15 SERIES PUMP DESIGN

Material Specification

NO	PART NAME	MATERIAL
1	DISCHARGE CHAMBER HOUSING	STEEL CAST 304
2	VALVE	S.S.304
3	VALVE SEAT	N.B.R. + S.S.304
4	SPACING WASHER	25% CFT
5	INTERMEDIATE CHAMBER TOP	S.S.304
6	BEARING BUSH	N.B.R.
7	NECKRING	N.B.R. + NYLON
8	INTERMEDIATE CHAMBER	S.S.304
9	COLLET & COLLET NUT	S.S.304
10	IMPELLER	S.S.304
11	INTERMEDIATE CHAMBER 1St	S.S.304
12	PUMP SHAFT (UP TO 26 STAGES)	S.S.431
	PUMP SHAFT (27 STAGE & ABOVE)	S.S.1.4362
13	CLAMPING STRIP	S.S.304
14	SUCTION CONNECTOR	S.S.304
15	STRAINER	S.S.304
16	PRIMING SCREW	S.S.304
17	NEMA COUPLING	S.S.304
18	CABLE GUARD	S.S.304
19	HEX NUT	S.S.316
20	SUCTION	STEEL CAST 304

Note:

PUMPS UP TO 20 STAGE DISCHARGE CHAMBER COMES WITH S.S. FABRICATED AND FROM 21 STAGE & ONWARDS WITH STEEL CAST.

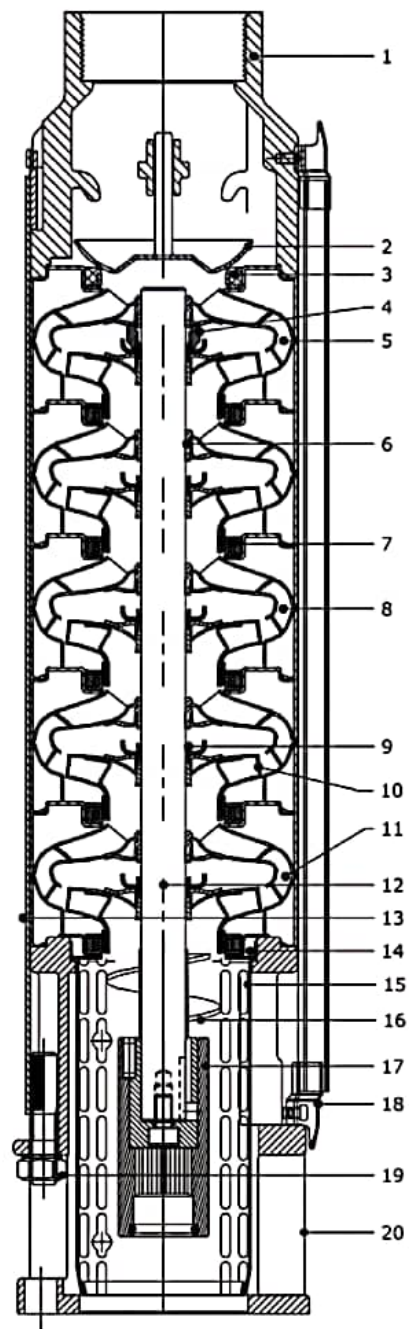

6VP 15, 50Hz
ISO 9906 Annexure A

PERFORMANCE CURVES

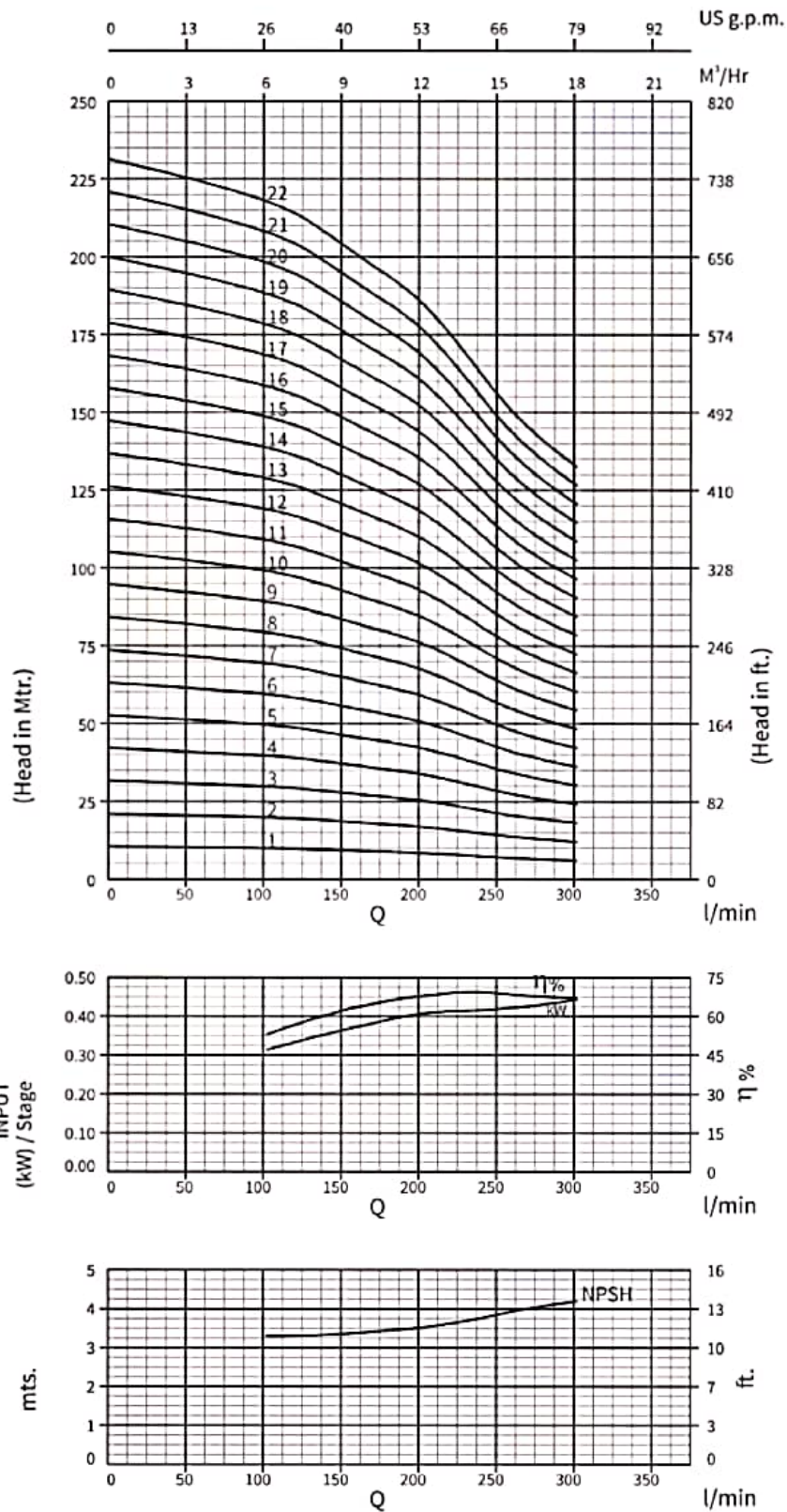

6VP 15, 50Hz
ISO 9906 Annexure A

PERFORMANCE CURVES

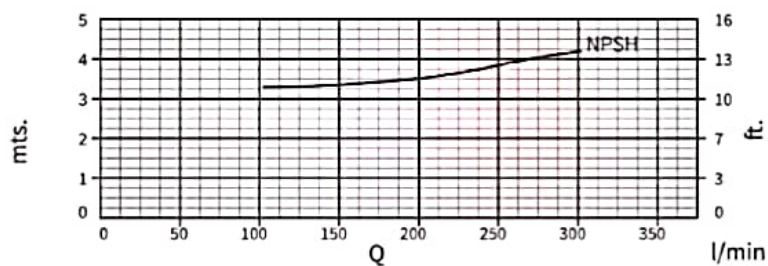
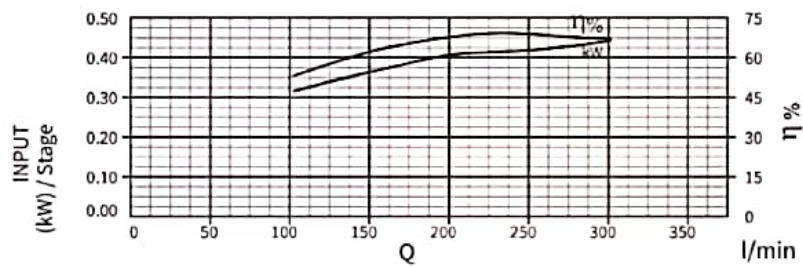
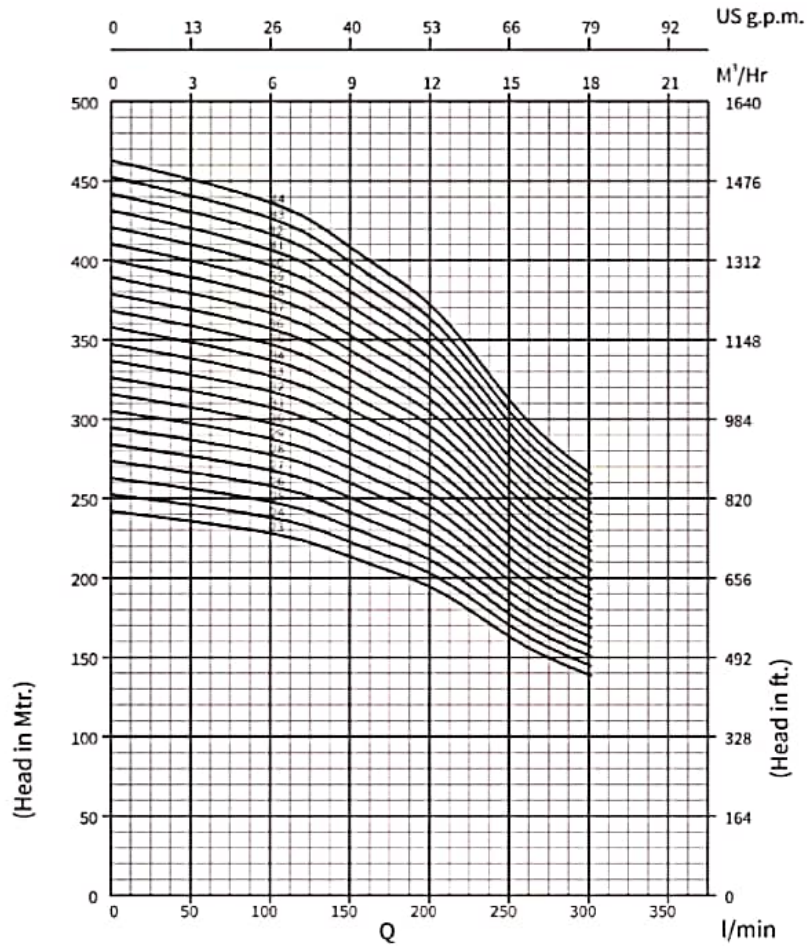

6VP 15, 50Hz
ISO 9906 Annexure A

PERFORMANCE CHART

MODEL NAME	STAGE	RATING		DISCHARGE								
		kW	HP		l/min	0	102	135	168	201	235	266

MODEL NAME	STAGE	kW	HP	DISCHARGE	0	102	135	168	201	235	266	302
6VP 15-01	1	0.55	0.75	10.5	10	9.5	9	8.5	7.5	7	6	
6VP 15-02	2	1.10	1.50	21	20	19	18	17	15	13	12	
6VP 15-03	3	1.50	2.00	32	30	29	27	26	23	20	18	
6VP 15-04	4	2.20	3.00	42	40	38	36	34	30	26	24	
6VP 15-05	5	2.20	3.00	53	50	48	45	43	38	33	30	
6VP 15-06	6	3.00	4.00	63	60	57	54	51	45	40	36	
6VP 15-07	7	3.00	4.00	74	70	67	63	60	53	46	42	
6VP 15-08	8	4.00	5.50	84	80	76	72	68	60	53	48	
6VP 15-09	9	4.00	5.50	95	90	86	81	77	68	59	54	
6VP 15-10	10	5.50	7.50	105	100	95	90	85	75	66	60	
6VP 15-11	11	5.50	7.50	116	110	105	99	94	83	73	66	
6VP 15-12	12	5.50	7.50	126	120	114	108	102	90	79	72	
6VP 15-13	13	7.50	10.00	137	130	124	117	111	98	86	78	
6VP 15-14	14	7.50	10.00	147	140	134	126	119	106	92	84	
6VP 15-15	15	7.50	10.00	158	150	143	135	128	113	99	90	
6VP 15-16	16	7.50	10.00	168	160	153	144	136	121	106	96	
6VP 15-17	17	9.30	12.50	179	170	162	153	145	128	112	102	
6VP 15-18	18	9.30	12.50	189	180	172	162	153	136	119	108	
6VP 15-19	19	9.30	12.50	200	190	181	171	162	143	125	114	
6VP 15-20	20	9.30	12.50	210	200	191	180	170	151	132	120	
6VP 15-21	21	11.00	15.00	221	210	200	189	179	158	139	126	
6VP 15-22	22	11.00	15.00	231	220	210	198	187	166	145	132	
6VP 15-23	23	11.00	15.00	242	230	219	207	196	173	152	138	
6VP 15-24	24	11.00	15.00	252	240	229	216	204	181	158	144	
6VP 15-25	25	13.00	17.50	263	250	238	224	213	188	165	150	
6VP 15-26	26	13.00	17.50	274	260	248	233	222	196	172	157	
6VP 15-27	27	13.00	17.50	284	270	258	242	230	204	178	163	
6VP 15-28	28	13.00	17.50	295	280	267	251	239	211	185	169	
6VP 15-29	29	15.00	20.00	305	290	277	260	247	219	191	175	
6VP 15-30	30	15.00	20.00	316	300	286	269	256	226	198	181	
6VP 15-31	31	15.00	20.00	326	310	296	278	264	234	205	187	
6VP 15-32	32	15.00	20.00	337	320	305	287	273	241	211	193	
6VP 15-33	33	15.00	20.00	347	330	315	296	281	249	218	199	
6VP 15-34	34	18.50	25.00	358	340	324	305	290	256	224	205	
6VP 15-35	35	18.50	25.00	368	350	334	314	298	264	231	211	
6VP 15-36	36	18.50	25.00	379	360	343	323	307	271	238	217	
6VP 15-37	37	18.50	25.00	389	370	353	332	315	279	244	223	
6VP 15-38	38	18.50	25.00	400	380	363	341	324	287	251	229	
6VP 15-39	39	18.50	25.00	410	390	372	350	332	294	257	235	
6VP 15-40	40	18.50	25.00	421	400	382	359	341	302	264	241	
6VP 15-41	41	22.00	30.00	431	410	391	368	349	309	271	247	
6VP 15-42	42	22.00	30.00	442	420	401	377	358	317	277	253	
6VP 15-43	43	22.00	30.00	452	430	410	386	366	324	284	259	
6VP 15-44	44	22.00	30.00	463	440	420	395	375	332	290	265	

HEAD IN Mtrs.

6VP 15, 50Hz
ISO 9906 Annexure A

Dimensions & Weights

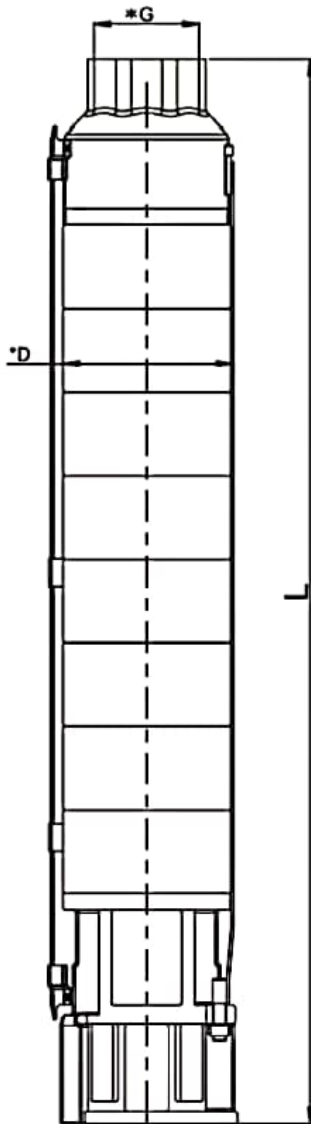

Model Name	Specification			
	*D (mm)	L (mm)	Pump Weight Kg	Weight (Incl. pkg) Kg
6VP 15 - 1	142	331	8	10
6VP 15 - 2	142	392	9	11
6VP 15 - 3	142	452	10	12
6VP 15 - 4	142	513	12	14
6VP 15 - 5	142	573	13	15
6VP 15 - 6	142	634	14	16
6VP 15 - 7	142	694	15	17
6VP 15 - 8	142	755	17	19
6VP 15 - 9	142	815	18	20
6VP 15 - 10	142	894	19	21
6VP 15 - 11	142	955	20	23
6VP 15 - 12	142	1015	22	24
6VP 15 - 13	142	1076	23	25
6VP 15 - 14	142	1136	24	26
6VP 15 - 15	142	1197	25	28
6VP 15 - 16	142	1257	26	29
6VP 15 - 17	142	1318	28	31
6VP 15 - 18	142	1378	29	32
6VP 15 - 19	142	1439	30	33
6VP 15 - 20	142	1499	31	34
6VP 15 - 21	142	1560	33	36
6VP 15 - 22	142	1620	34	37
6VP 15 - 23	142	1681	35	39
6VP 15 - 24	142	1741	36	40
6VP 15 - 25	142	1802	38	41
6VP 15 - 26	142	1862	39	42
6VP 15 - 27	142	1923	40	43
6VP 15 - 28	142	1983	41	45
6VP 15 - 29	142	2044	42	46
6VP 15 - 30	142	2104	44	47
6VP 15 - 31	142	2165	45	49
6VP 15 - 32	142	2225	46	50
6VP 15 - 33	142	2286	47	51
6VP 15 - 34	142	2346	49	53
6VP 15 - 35	142	2407	50	54
6VP 15 - 36	142	2467	51	55
6VP 15 - 37	142	2528	52	56
6VP 15 - 38	142	2588	53	57
6VP 15 - 39	142	2649	55	59
6VP 15 - 40	142	2709	56	60
6VP 15 - 41	142	2770	57	62
6VP 15 - 42	142	2830	58	63
6VP 15 - 43	142	2891	60	64
6VP 15 - 44	142	2951	61	65

*G : Available Outlet Size BSP 2.5"

*D : With Cable Guard

6VP 15-01 to 6VP 15-16 Pumps Are Also Available
In 4" Joining

6VP 18 SERIES PUMP DESIGN

Material Specification

NO	PART NAME	MATERIAL
1	DISCHARGE CHAMBER HOUSING	STEEL CAST 304
2	VALVE	S.S.304
3	VALVE SEAT	N.B.R. + S.S.304
4	SPACING WASHER	25% CFT
5	INTERMEDIATE CHAMBER TOP	S.S.304
6	BEARING BUSH	N.B.R.
7	NECKRING	N.B.R. + NYLON
8	INTERMEDIATE CHAMBER	S.S.304
9	COLLET & COLLET NUT	S.S.304
10	IMPELLER	S.S.304
11	INTERMEDIATE CHAMBER 1st	S.S.304
12	PUMP SHAFT (UP TO 26 STAGES)	S.S.431
	PUMP SHAFT (27 STAGE & ABOVE)	S.S.1.4362
13	CLAMPING STRIP	S.S.304
14	SUCTION CONNECTOR	S.S.304
15	STRAINER	S.S.304
16	PRIMING SCREW	S.S.304
17	NEMA COUPLING	S.S.304
18	CABLE GUARD	S.S.304
19	HEX NUT	S.S.316
20	SUCTION	STEEL CAST 304

Note:

PUMPS UP TO 20 STAGE DISCHARGE CHAMBER COMES WITH S.S. FABRICATED AND FROM 21 STAGE & ONWARDS WITH STEEL CAST.

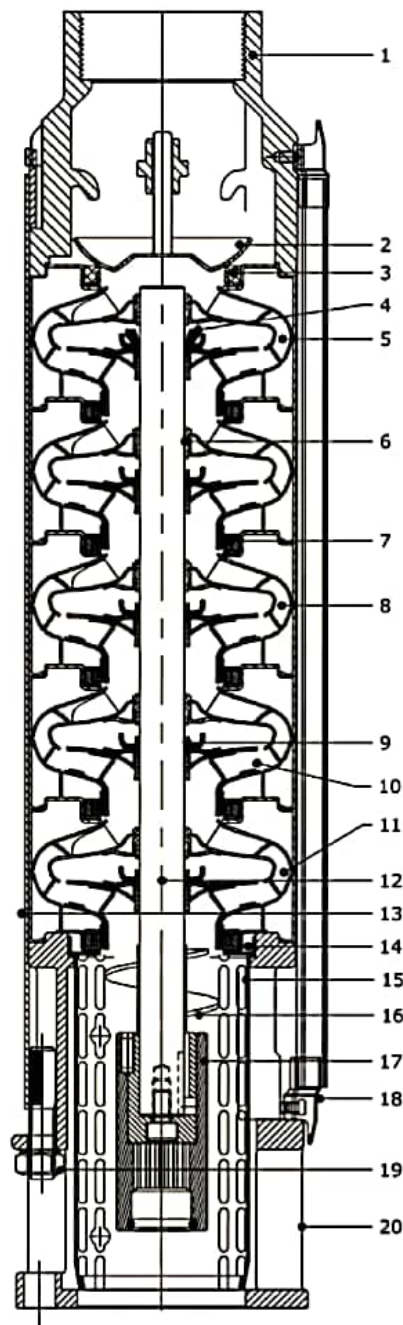

6VP 18, 50Hz
ISO 9906 Annexure A

PERFORMANCE CURVES

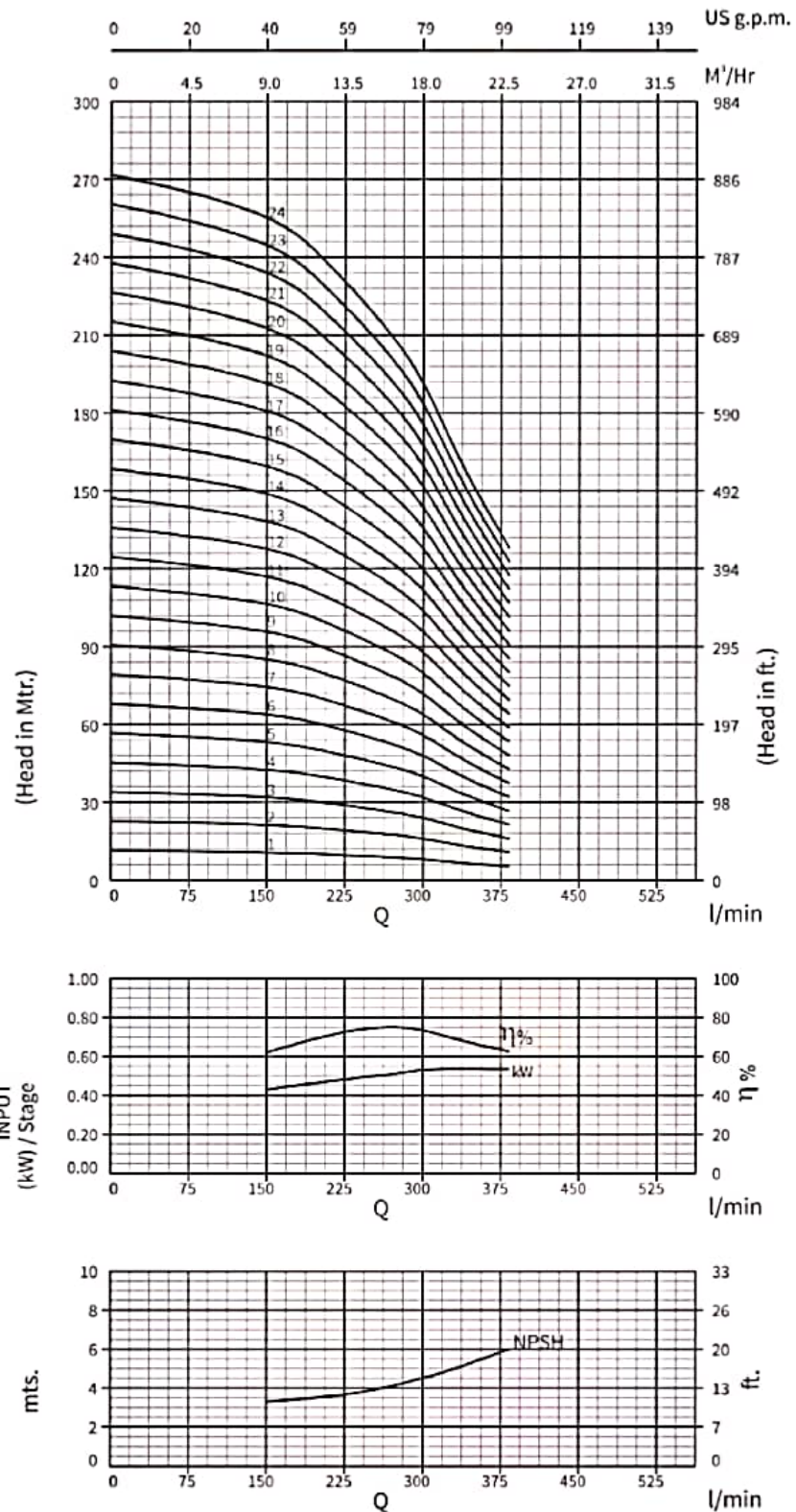

6VP 18, 50Hz
ISO 9906 Annexure A

PERFORMANCE CHART

MODEL NAME	STAGE	RATING		l/min m ³ /h	Discharge						
		kW	HP		0	150	200	250	300	333	383

MODEL NAME	STAGE	kW	HP	HEAD IN Mtrs.	0	150	200	250	300	333	383
6VP 18-01	1	0.55	0.75	11.3	11	10	9	8	7	5	
6VP 18-02	2	1.10	1.50	23	22	20	18	16	13	11	
6VP 18-03	3	2.20	3.00	34	32	30	27	24	20	16	
6VP 18-04	4	2.20	3.00	45	43	40	37	33	27	21	
6VP 18-05	5	3.00	4.00	57	54	50	46	41	34	27	
6VP 18-06	6	4.00	5.50	68	65	60	55	49	40	32	
6VP 18-07	7	4.00	5.50	79	76	70	64	57	47	37	
6VP 18-08	8	5.50	7.50	91	87	80	73	65	54	43	
6VP 18-09	9	5.50	7.50	102	97	91	82	73	60	48	
6VP 18-10	10	5.50	7.50	113	108	101	92	81	67	53	
6VP 18-11	11	7.50	10.00	125	119	111	101	89	74	59	
6VP 18-12	12	7.50	10.00	136	130	121	110	98	80	64	
6VP 18-13	13	7.50	10.00	147	141	131	119	106	87	69	
6VP 18-14	14	9.30	12.50	158	152	141	128	114	94	75	
6VP 18-15	15	9.30	12.50	170	162	151	137	122	100	80	
6VP 18-16	16	9.30	12.50	181	173	161	147	130	107	85	
6VP 18-17	17	9.30	12.50	192	184	171	156	138	114	91	
6VP 18-18	18	11.00	15.00	204	195	181	165	146	121	96	
6VP 18-19	19	11.00	15.00	215	206	191	174	154	127	101	
6VP 18-20	20	11.00	15.00	226	217	201	183	163	134	107	
6VP 18-21	21	13.00	17.50	238	227	211	192	171	141	112	
6VP 18-22	22	13.00	17.50	249	238	221	202	179	147	117	
6VP 18-23	23	13.00	17.50	260	249	231	211	187	154	123	
6VP 18-24	24	13.00	17.50	272	260	241	220	195	161	128	

6VP 18, 50Hz
ISO 9906 Annexure A

PERFORMANCE CURVES

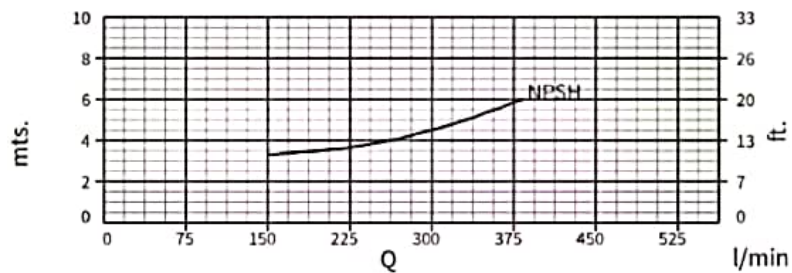
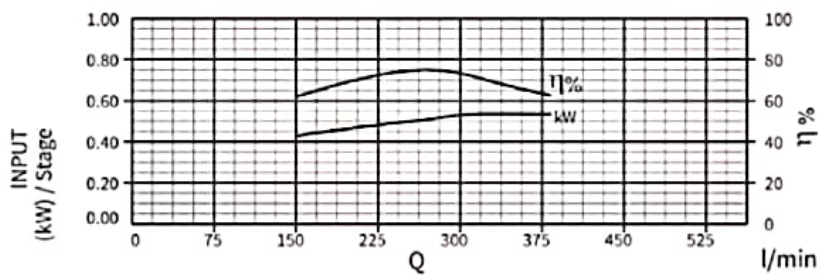
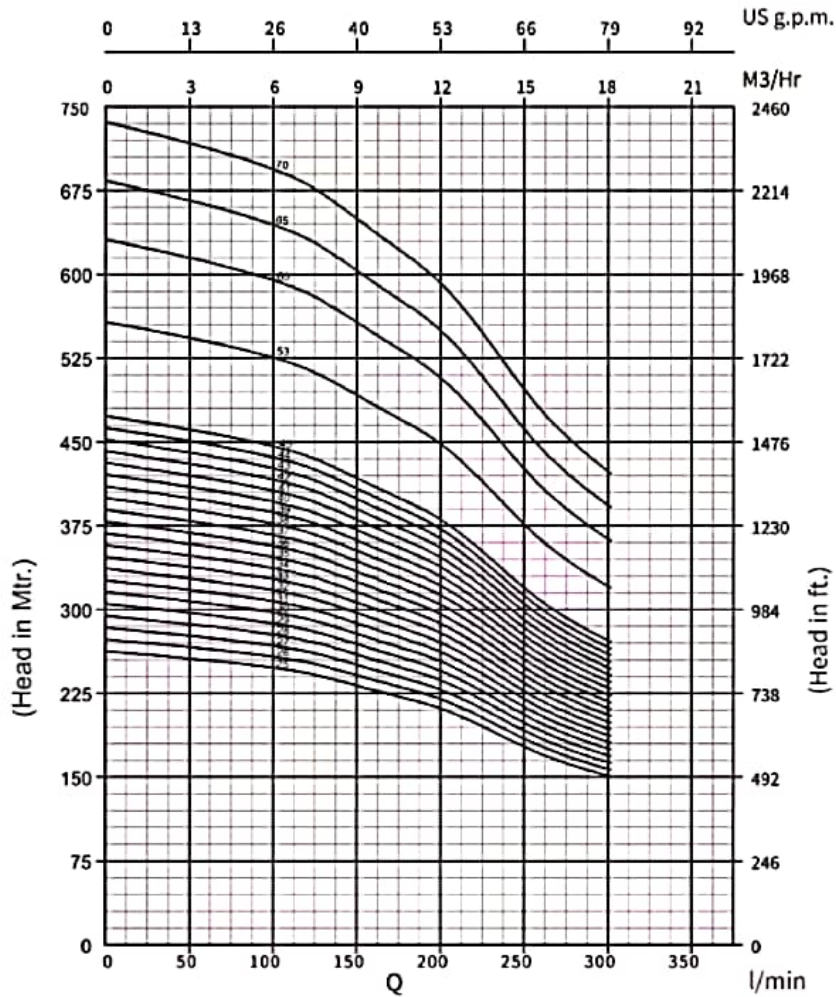

6VP 18, 50Hz
ISO 9906 Annexure A

PERFORMANCE CHART

MODEL NAME	STAGE	RATING		Discharge							
		kW	HP	l/min	0	150	200	250	300	333	383
				m ³ /h	0	9	12	15	18	20	23

MODEL NAME	STAGE	kW	HP	HEAD IN Mtrs.	0	150	200	250	300	333	383
6VP 18-25	25	15.00	20.00	283	271	252	229	203	168	133	
6VP 18-26	26	15.00	20.00	294	282	262	238	211	174	139	
6VP 18-27	27	15.00	20.00	306	292	272	247	220	181	144	
6VP 18-28	28	18.50	25.00	317	303	282	256	228	188	149	
6VP 18-29	29	18.50	25.00	328	314	292	266	236	194	155	
6VP 18-30	30	18.50	25.00	340	325	302	275	244	201	160	
6VP 18-31	31	18.50	25.00	351	336	312	284	252	208	165	
6VP 18-32	32	18.50	25.00	362	347	322	293	260	214	171	
6VP 18-33	33	18.50	25.00	374	357	332	302	268	221	176	
6VP 18-34	34	22.00	30.00	385	368	342	311	276	228	181	
6VP 18-35	35	22.00	30.00	396	379	352	321	285	234	187	
6VP 18-36	36	22.00	30.00	408	390	362	330	293	241	192	
6VP 18-37	37	22.00	30.00	419	401	372	339	301	248	197	
6VP 18-38	38	22.00	30.00	430	412	382	348	309	255	203	
6VP 18-39	39	22.00	30.00	441	422	392	357	317	261	208	
6VP 18-40	40	22.00	30.00	453	433	402	366	325	268	213	
6VP 18-43	43	26.00	35.00	487	466	433	394	350	288	229	
6VP 18-45	45	26.00	35.00	509	487	453	412	366	302	240	
6VP 18-48	48	26.00	35.00	543	520	483	440	390	322	256	
6VP 18-51	51	30.00	40.00	577	552	513	467	415	342	272	
6VP 18-53	53	30.00	40.00	600	574	533	485	431	355	282	
6VP 18-55	55	37.00	50.00	623	596	553	504	447	368	293	
6VP 18-58	58	37.00	50.00	657	628	583	531	472	389	309	
6VP 18-60	60	37.00	50.00	679	650	604	550	488	402	320	

6VP 18, 50Hz
ISO 9906 Annexure A

Dimensions & Weights

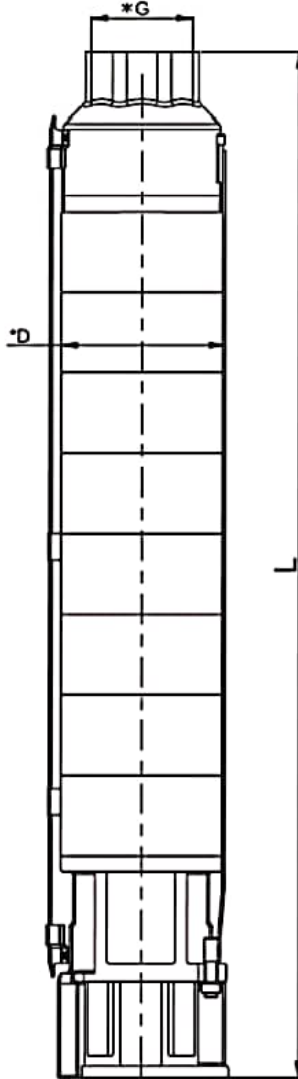

Model Name	Specification			
	*D (mm)	L (mm)	Pump Weight Kg.	Weight (Incl. pkg.) Kg.
6VP-18 - 01	142	331	8	10
6VP-18 - 02	142	392	9	11
6VP-18 - 03	142	452	11	12
6VP-18 - 04	142	513	12	13
6VP-18 - 05	142	573	13	15
6VP-18 - 06	142 ^U	634	14	16
6VP-18 - 07	142	694	16	18
6VP-18 - 08	142	755	17	19
6VP-18 - 09	142	815	18	20
6VP-18 - 10	142	894	19	21
6VP-18 - 11	142	955	21	23
6VP-18 - 12	142	1015	22	24
6VP-18 - 13	142	1076	23	26
6VP-18 - 14	142	1136	24	27
6VP-18 - 15	142	1197	26	28
6VP-18 - 16	142	1257	27	30
6VP-18 - 17	142	1318	28	31
6VP-18 - 18	142	1378	29	32
6VP-18 - 19	142	1439	31	34
6VP-18 - 20	142	1499	32	35
6VP-18 - 21	142	1560	33	37
6VP-18 - 22	142	1620	34	38
6VP-18 - 23	142	1681	36	39
6VP-18 - 24	142	1741	37	40
6VP-18 - 25	142	1802	38	42
6VP-18 - 26	142	1862	39	43
6VP-18 - 27	142	1923	41	44
6VP-18 - 28	142	1983	42	45
6VP-18 - 29	142	2044	43	47
6VP-18 - 30	142	2104	44	48
6VP-18 - 31	142	2165	46	50
6VP-18 - 32	142	2225	47	51
6VP-18 - 33	142	2286	48	52
6VP-18 - 34	142	2346	49	53
6VP-18 - 35	142	2407	51	55
6VP-18 - 36	142	2467	52	56
6VP-18 - 37	142	2528	53	57
6VP-18 - 38	142	2588	54	58
6VP-18 - 39	142	2649	56	60
6VP-18 - 40	142	2709	57	61
6VP-18 - 43	142	2891	62	66
6VP-18 - 45	142	3012	64	68
6VP-18 - 48	142	3193	67	71
6VP-18 - 51	142	3375	71	75
6VP-18 - 53	142	3496	73	77
6VP-18 - 55	142	3617	75	79
6VP-18 - 58	142	3798	79	84
6VP-18 - 60	142	3919	81	86

*G : Available Outlet Size 2.5" BSP & 3.0" BSP

*D : With Cable Guard

6VP-18 -01 to 6VP-18 -13 pumps are also available in 4" joining.

6VP 32 SERIES PUMP DESIGN

Material Specification

NO	PART NAME	MATERIAL
1	DISCHARGE CHAMBER HOUSING	STEEL CAST 304
2	VALVE	S.S.304
3	VALVE SEAT	N.B.R. + S.S.304
4	TOP & FIRST BEARING BUSH	N.B.R. + S.S.304
5	INTERMEDIATE CHAMBER TOP	S.S.304
6	NECKRING	N.B.R. + NYLON
7	BEARING BUSH	N.B.R.
8	INTER MEDIATE CHAMBER	S.S.304
9	COLLET NUT	S.S.304
10	IMPELLER	S.S.304
11	COLLET	S.S.304
12	PUMP SHAFT (UP TO 18 STAGES)	S.S.431
12	PUMP SHAFT (19 STAGE & ABOVE)	S.S.1.4362
13	INTER MEDIATE CHAMBER 1st	S.S.304
14	SPACING WASHER	25% CFT
15	CONNECTOR	S.S.304
16	STRAINER	S.S.304
17	CLAMPING STRIP	S.S.304
18	CABLE GUARD	S.S.304
19	NEMA COUPLING	S.S.304
20	HEX NUT	S.S.316
20	SUCTION	STEEL CAST 304

Note:

PUMPS UP TO 20 STAGE DISCHARGE CHAMBER COMES WITH S.S. FABRICATED AND FROM 21 STAGE & ONWARDS WITH STEEL CAST.

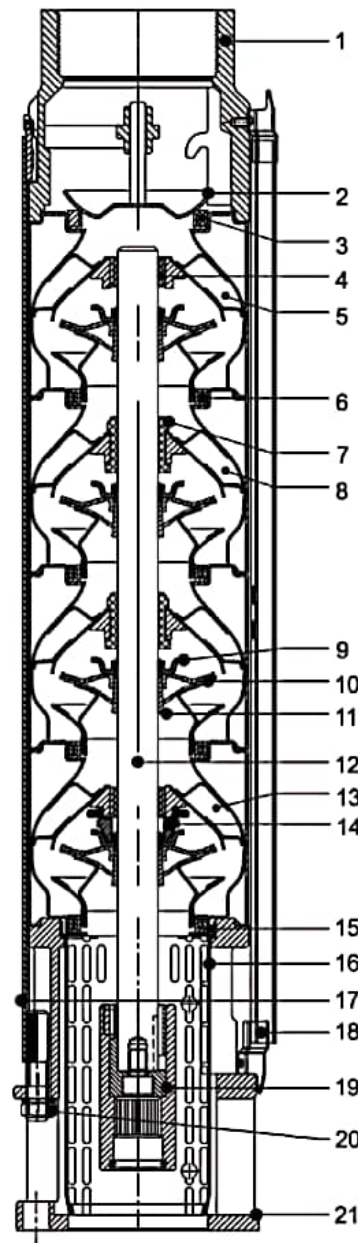

6VP 32, 50Hz
ISO 9906 Annexure A

PERFORMANCE CURVES

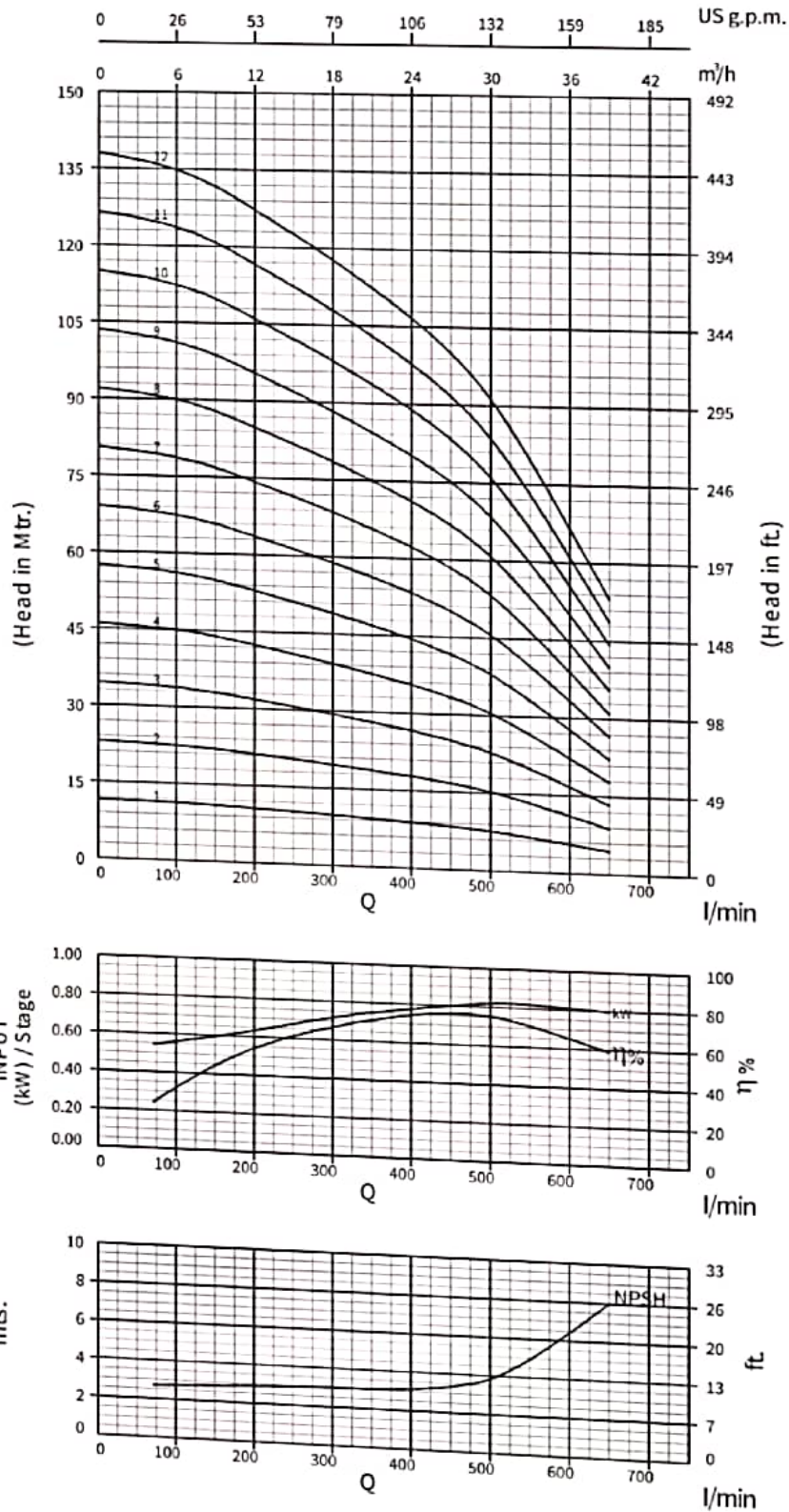

6VP 32, 50Hz
ISO 9906 Annexure A

PERFORMANCE CURVES

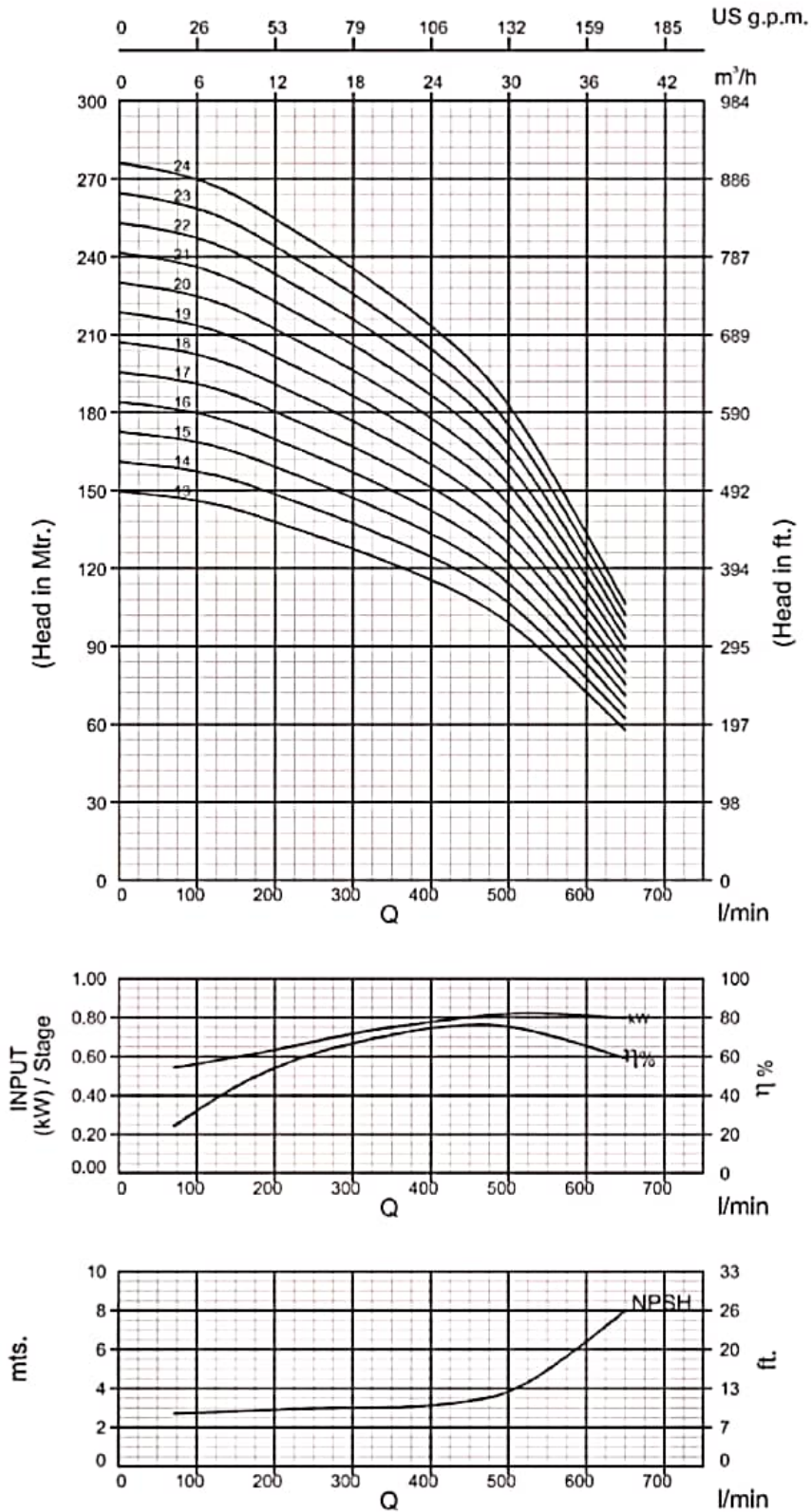

6VP 32, 50Hz
ISO 9906 Annexure A

PERFORMANCE CURVES

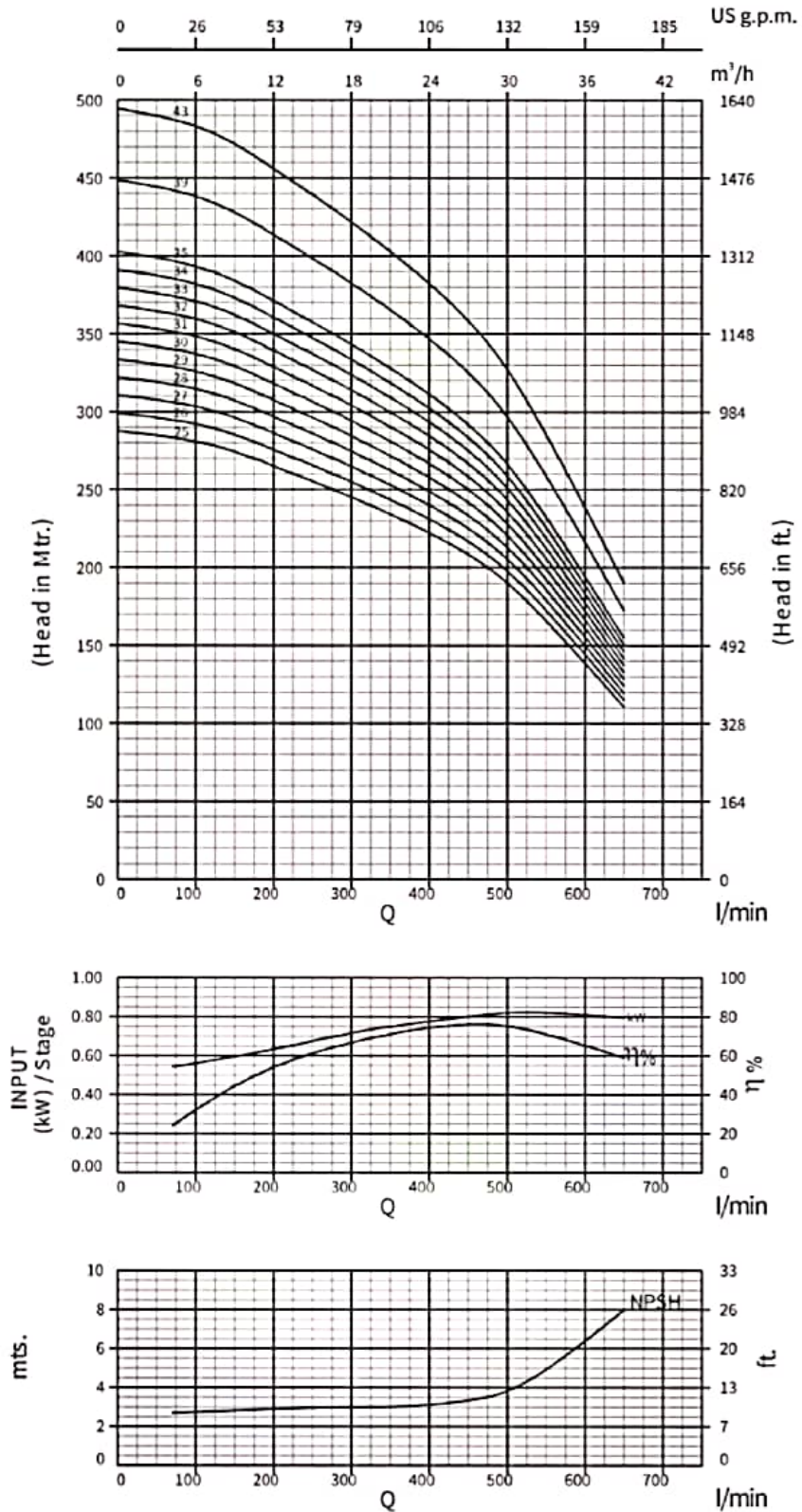

6VP 32, 50Hz
ISO 9906 Annexure A

PERFORMANCE CHART

Model Name	Stage	Rating		l/min m ³ /h	Discharge									
		kW	HP		0	70	135	200	270	335	400	470	535	650

Model Name	Stage	kW	HP	0	70	135	200	270	335	400	470	535	650
6VP 32-01	1	1.10	1.50	11.5	11.3	11	10.5	10	9.5	9	8	7	4
6VP 32-02	2	2.20	3.00	23	22.5	22	21	20	19	18	16	14	9
6VP 32-03	3	3.00	4.00	34.5	34	33	32	30	29	27	24	21	13
6VP 32-04	4	4.00	5.50	46	45	44	42	40	38	36	33	28	18
6VP 32-05	5	5.50	7.50	58	57	56	53	50	48	45	41	35	22
6VP 32-06	6	5.50	7.50	69	68	67	64	60	57	53	49	42	27
6VP 32-07	7	7.50	10.00	80.5	80	78	74	70	67	62	57	49	31
6VP 32-08	8	7.50	10.00	92	91	89	85	81	76	71	65	56	35
6VP 32-09	9	9.30	12.50	104	102	100	95	91	86	80	73	63	40
6VP 32-10	10	9.30	12.50	115	114	111	106	101	95	89	81	70	44
6VP 32-11	11	9.30	12.50	126	125	122	117	111	105	98	90	78	49
6VP 32-12	12	11.00	15.00	138	136	133	127	121	114	107	98	85	53
6VP 32-13	13	11.00	15.00	150	148	145	138	131	124	116	106	92	57
6VP 32-14	14	13.00	17.50	161	159	156	148	141	133	125	114	99	62
6VP 32-15	15	13.00	17.50	172	171	167	159	151	143	134	122	106	66
6VP 32-16	16	15.00	20.00	184	182	178	170	161	152	143	130	113	71
6VP 32-17	17	15.00	20.00	196	193	189	180	171	162	151	138	120	75
6VP 32-18	18	18.50	25.00	207	205	200	191	181	171	160	147	127	80
6VP 32-19	19	18.50	25.00	218	216	211	201	191	181	169	155	134	84
6VP 32-20	20	18.50	25.00	230	227	222	212	201	190	178	163	141	88
6VP 32-21	21	18.50	25.00	242	239	234	223	211	200	187	171	148	93
6VP 32-22	22	22.00	30.00	253	250	245	233	222	209	196	179	155	97
6VP 32-23	23	22.00	30.00	264	262	256	244	232	219	205	187	162	102
6VP 32-24	24	22.00	30.00	276	273	267	254	242	228	214	195	169	106
6VP 32-25	25	22.00	30.00	288	284	278	265	252	238	223	204	176	110
6VP 32-26	26	22.00	30.00	299	296	289	276	262	247	232	212	183	115
6VP 32-27	27	26.00	35.00	310	307	300	286	272	257	241	220	190	119
6VP 32-28	28	26.00	35.00	322	318	311	297	282	266	249	228	197	124
6VP 32-29	29	26.00	35.00	334	330	322	307	292	276	258	236	204	128
6VP 32-30	30	26.00	35.00	345	341	334	318	302	285	267	244	212	133
6VP 32-31	31	26.00	35.00	356	352	345	329	312	295	276	252	219	137
6VP 32-32	32	30.00	40.00	368	364	356	339	322	304	285	260	226	141
6VP 32-33	33	30.00	40.00	380	375	367	350	332	314	294	269	233	146
6VP 32-34	34	30.00	40.00	391	387	378	360	342	323	303	277	240	150
6VP 32-35	35	30.00	40.00	402	398	389	371	352	333	312	285	247	155
6VP 32-39	39	37.00	50.00	448	443	434	413	393	371	347	317	275	172
6VP 32-43	43	37.00	50.00	494	489	478	456	433	409	383	350	303	190

HEAD IN Mtrs.

6VP 32, 50Hz
ISO 9906 Annexure A

Dimensions & Weights

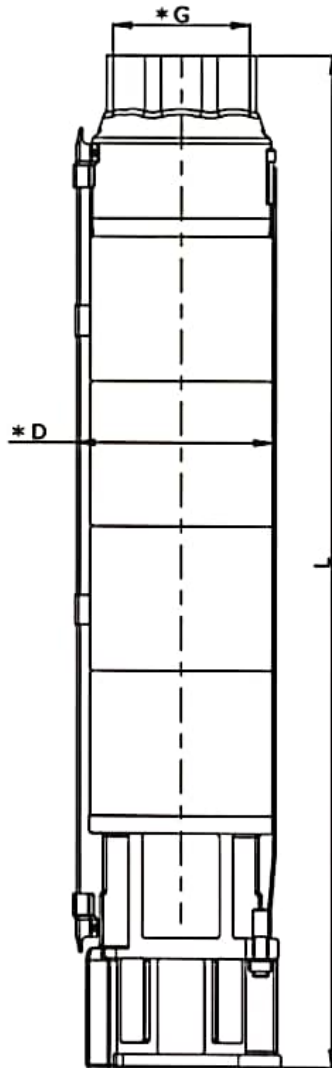

Model Name	Specification			
	*D (mm)	L (mm)	Pump Weight Kg.	Weight (Incl. pkg.) Kg.
6VP 32 - 01	142	369	9	10
6VP 32 - 02	142	465	11	12
6VP 32 - 03	142	561	13	15
6VP 32 - 04	142	657	15	17
6VP 32 - 05	142	753	17	19
6VP 32 - 06	142	849	19	22
6VP 32 - 07	142	947	21	24
6VP 32 - 08	142	1041	23	26
6VP 32 - 09	142	1137	25	28
6VP 32 - 10	142	1249	27	31
6VP 32 - 11	142	1345	29	33
6VP 32 - 12	142	1441	31	35
6VP 32 - 13	142	1537	33	37
6VP 32 - 14	142	1633	35	40
6VP 32 - 15	142	1729	37	42
6VP 32 - 16	142	1825	39	44
6VP 32 - 17	142	1921	41	47
6VP 32 - 18	142	2017	43	49
6VP 32 - 19	142	2113	45	51
6VP 32 - 20	142	2209	47	53
6VP 32 - 21	142	2305	49	56
6VP 32 - 22	142	2401	51	58
6VP 32 - 23	142	2497	53	60
6VP 32 - 24	142	2593	55	62
6VP 32 - 25	142	2689	57	65
6VP 32 - 26	142	2785	59	67
6VP 32 - 27	142	2881	61	69
6VP 32 - 28	142	2977	63	72
6VP 32 - 29	142	3073	65	74
6VP 32 - 30	142	3169	67	76
6VP 32 - 31	142	3265	69	78
6VP 32 - 32	142	3361	71	81
6VP 32 - 33	142	3457	73	83
6VP 32 - 34	142	3553	75	85
6VP 32 - 35	142	3631	77	87
6VP 32 - 39	142	4033	87	96
6VP 32 - 43	142	4417	95	106
6VP 32 - 46	142	4705	99	112
6VP 32 - 49	142	4993	105	119
6VP 32 - 52	142	5281	111	126
6VP 32 - 54	142	5473	115	131
6VP 32 - 58	142	5857	123	140
6VP 32 - 60	142	6049	127	144

*G : Available Outlet Size 3.0" BSP

*D : With Cable Guard

6VP 32 -01 to 6VP 32 -08 pumps are also available in 4" joining.

6VP 32 -46, 6VP 32 -49, 6VP 32 -52, 6VP 32 -54, 6VP -58 & 6VP 32 -60 pumps are also available with & without mounted sleeve in 8" joining.

6VP 48 & 6VP 62 SERIES PUMP DESIGN

Material Specification

No	PART NAME	MATERIAL
1	DISCHARGE CHAMBER HOUSING	STEEL CAST 304
2	VALVE	S.S.304
3	TOP & FIRST BEARING BUSH	N.B.R. + S.S.304
4	INTERMEDIATE CHAMBER TOP	S.S.304
5	COLLET NUT	S.S.304
6	IMPELLER	S.S.304
7	COLLET	S.S.304
8	BEARING BUSH	NBR
9	INTERMEDIATE CHAMBER STAGE	S.S.304
10	NECKRING	N.B.R. + NYLON
11	INTERMEDIATE CHAMBER 1st	S.S.304
12	SPACING WASHER	25% CFT
13	FIRST STAGE NUT	STEEL CAST 304
14	RETAINER	S.S.304
15	STRAINER	S.S.304
16	PUMP SHAFT (UP TO 09 STAGES)	S.S.431
	PUMP SHAFT (10 STAGE & ABOVE)	S.S.1.4362
17	NEMA COUPLING	S.S.304
18	CABLE GUARD	S.S.304
19	CLAMPING STRIP	S.S.304
20	HEX NUT	S.S. 316
21	SUCTION	STEEL CAST 304

Note:

PUMPS UP TO 20 STAGE DISCHARGE CHAMBER COMES WITH S.S. FABRICATED AND FROM 21 STAGE & ONWARDS WITH STEEL CAST.

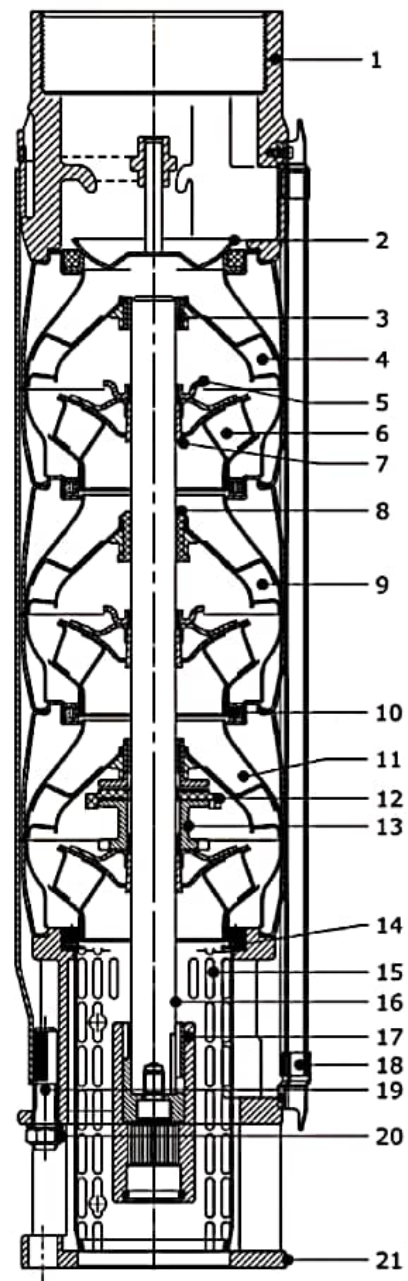

6VP 48, 50Hz
ISO 9906 Annexure A

PERFORMANCE CURVES

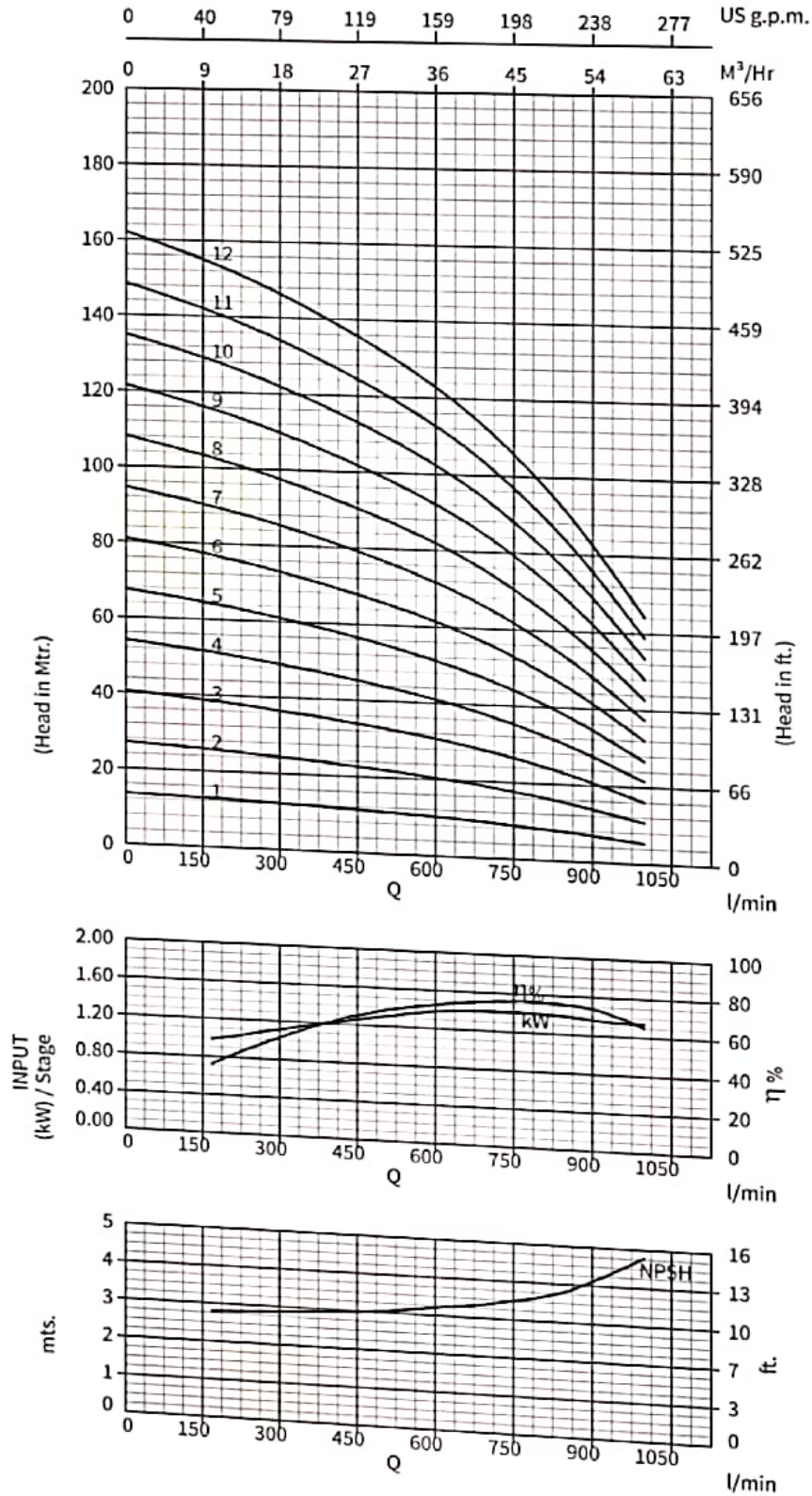

6VP 48, 50Hz
 ISO 9906 Annexure A

PERFORMANCE CURVES

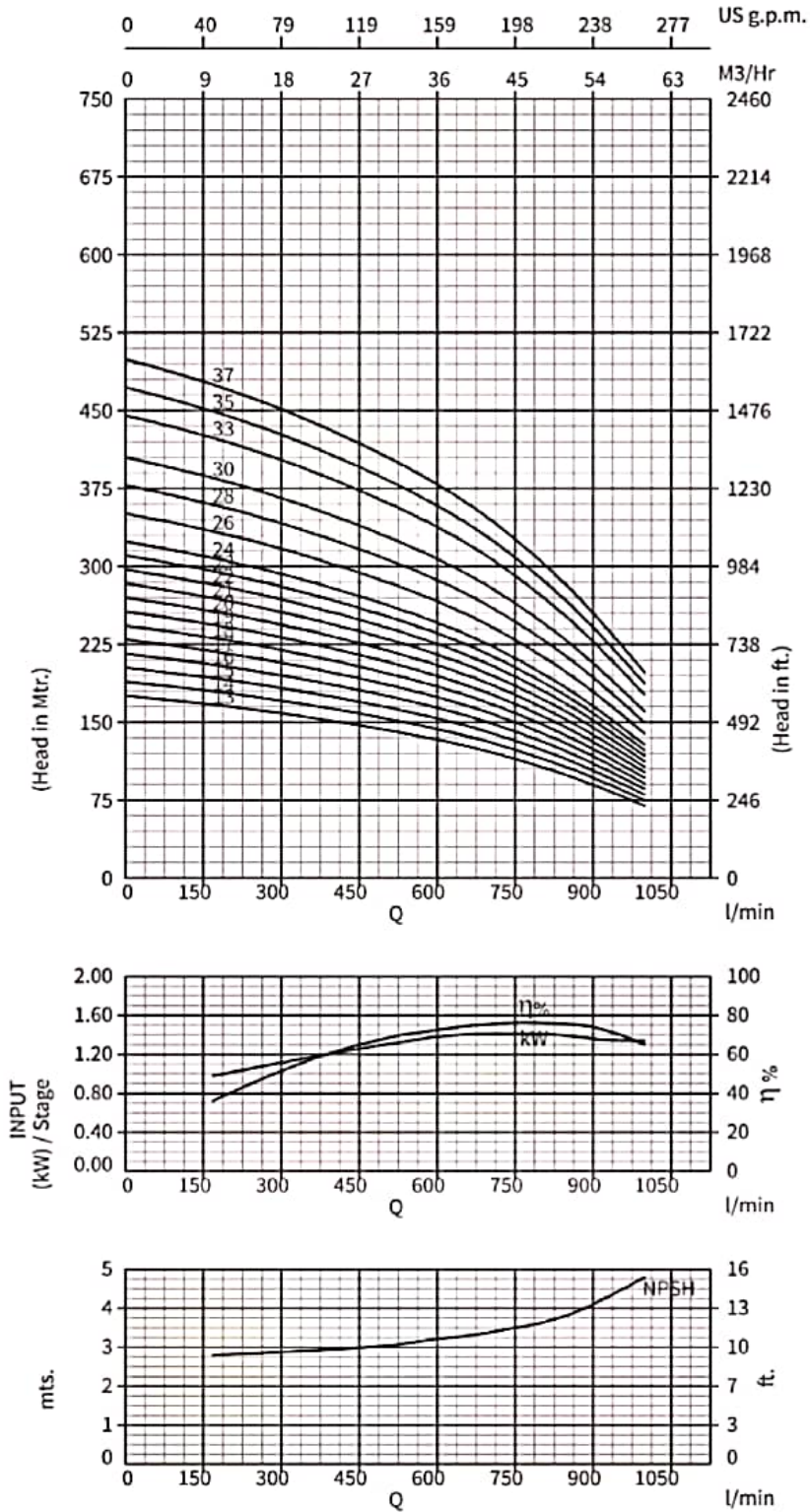

6VP 48, 50Hz
ISO 9906 Annexure A

PERFORMANCE CHART

MODEL NAME	STAGE	RATING		DISCHARGE										
		kW	HP	l/min	0	167	335	500	585	670	750	835	917	1000
THREE PHASE				m ³ /h	0	10.0	20.1	30.0	35.1	40.2	45.0	50.1	55.0	60.0

MODEL NAME	STAGE	kW	HP	HEAD IN Mtrs.	14	13	12	11	10	9.5	9	8	7	5
6VP 48-01	1	2.20	3.00		14	13	12	11	10	9.5	9	8	7	5
6VP 48-02	2	3.00	4.00		27	26	24	22	21	19	18	16	13	11
6VP 48-03	3	5.50	7.50		40	39	36	33	31	29	26	23	20	16
6VP 48-04	4	7.50	10.00		54	52	48	44	41	39	35	31	27	21
6VP 48-05	5	7.50	10.00		68	64	60	55	52	48	44	39	33	27
6VP 48-06	6	9.30	12.50		81	77	72	66	62	58	53	47	40	32
6VP 48-07	7	11.00	15.00		94	90	84	77	73	68	62	55	47	37
6VP 48-08	8	13.00	17.50		108	103	96	88	83	77	71	63	53	43
6VP 48-09	9	15.00	20.00		122	116	108	99	93	87	79	70	60	48
6VP 48-10	10	15.00	20.00		135	129	120	110	104	97	88	78	67	53
6VP 48-11	11	18.50	25.00		148	142	132	121	114	106	97	86	73	59
6VP 48-12	12	18.50	25.00		162	155	144	132	124	116	106	94	80	64
6VP 48-13	13	22.00	30.00		176	168	157	143	135	126	115	102	87	69
6VP 48-14	14	22.00	30.00		189	181	169	154	145	135	124	110	93	75
6VP 48-15	15	22.00	30.00		202	194	181	165	156	145	132	117	100	80
6VP 48-16	16	26.00	35.00		216	206	193	176	166	155	141	125	107	85
6VP 48-17	17	26.00	35.00		230	219	205	187	176	164	150	133	113	91
6VP 48-18	18	30.00	40.00		243	232	217	198	187	174	159	141	120	96
6VP 48-19	19	30.00	40.00		256	245	229	209	197	184	168	149	127	101
6VP 48-20	20	30.00	40.00		270	258	241	220	207	193	177	157	133	107
6VP 48-21	21	37.00	50.00		284	271	253	231	218	203	185	164	140	112
6VP 48-22	22	37.00	50.00		297	284	265	242	228	213	194	172	147	117
6VP 48-23	23	37.00	50.00		310	297	277	253	239	222	203	180	153	123
6VP 48-24	24	37.00	50.00		324	310	289	264	249	232	212	188	160	128
6VP 48-26	26	45.00	60.00		351	335	313	286	270	251	230	204	173	139
6VP 48-28	28	45.00	60.00		378	361	337	308	290	271	247	219	187	149
6VP 48-30	30	45.00	60.00		405	387	361	330	311	290	265	235	200	160
6VP 48-33	33	55.00	75.00		446	426	397	363	342	319	291	258	220	176
6VP 48-35	35	55.00	75.00		472	452	421	385	363	338	309	274	233	187
6VP 48-37	37	63.00	85.00		500	477	445	407	384	358	327	290	247	197

6VP 48, 50Hz
ISO 9906 Annexure A

Dimensions & Weights

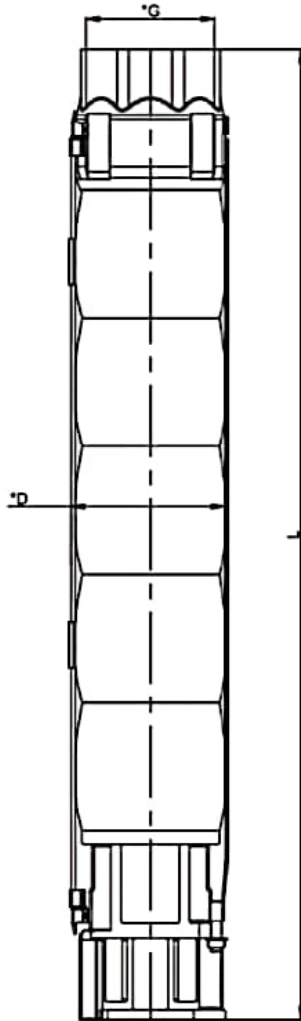

Model Name	Specification			
	*D (mm)	L (mm)	Pump Weight Kg.	Weight (Incl. pkg.) Kg.
6VP 48 - 01	147	400	10	12
6VP 48 - 02	147	513	12	14
6VP 48 - 03	147	628	14	16
6VP 48 - 04	147	741	16	18
6VP 48 - 05	147	854	18	21
6VP 48 - 06	147	967	20	23
6VP 48 - 07	147	1080	22	25
6VP 48 - 08	147	1193	24	28
6VP 48 - 09	147	1306	26	30
6VP 48 - 10	147	1424	28	32
6VP 48 - 11	147	1537	30	35
6VP 48 - 12	147	1650	32	37
6VP 48 - 13	147	1763	34	39
6VP 48 - 14	147	1876	36	41
6VP 48 - 15	147	1989	38	44
6VP 48 - 16	147	2102	40	46
6VP 48 - 17	147	2215	42	48
6VP 48 - 18	147	2328	44	51
6VP 48 - 19	147	2441	46	53
6VP 48 - 20	147	2554	48	55
6VP 48 - 21	147	2667	50	58
6VP 48 - 22	147	2780	52	60
6VP 48 - 23	147	2893	54	62
6VP 48 - 24	147	3006	56	64
6VP 48 - 26	147	3232	60	69
6VP 48 - 28	147	3458	64	74
6VP 48 - 30	147	3684	68	78
6VP 48 - 33	147	4023	74	85

*G : Available outlet size 3" BSP & 4" BSP

*D : With cable Guard

6VP 48 -01 to 6VP 48 -05 pumps are also available in 4" joining.

6VP 48 -26, 6VP 48 -28, 6VP 48 -30, 6VP 48 -33, 6VP 48 -35 & 6VP 48 -37 pumps are also available with & without mounted sleeve in 8" joining.

6VP 62, 50Hz
ISO 9906 Annexure A

PERFORMANCE CURVES

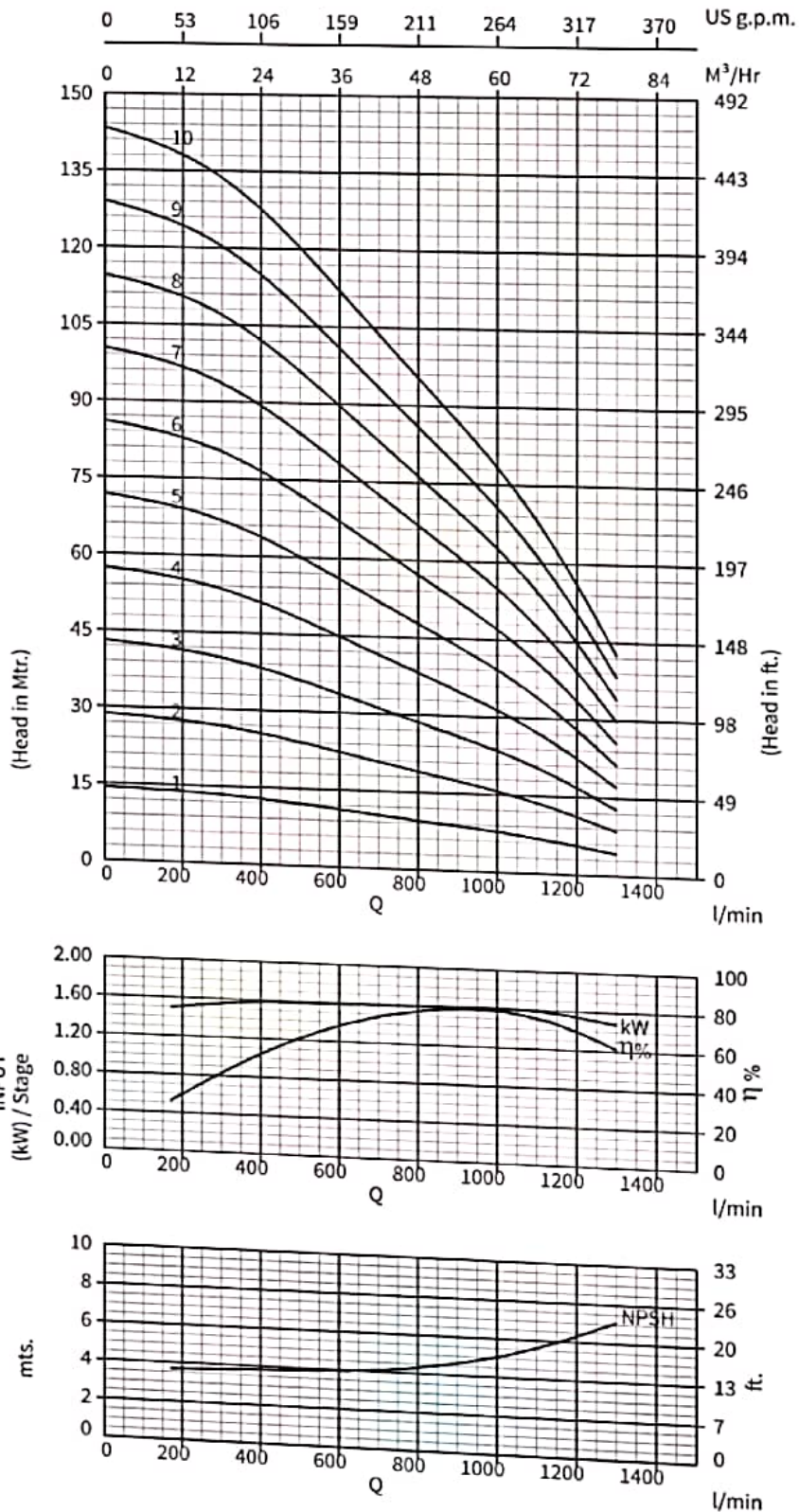

6VP 62, 50Hz
ISO 9906 Annexure A

PERFORMANCE CURVES

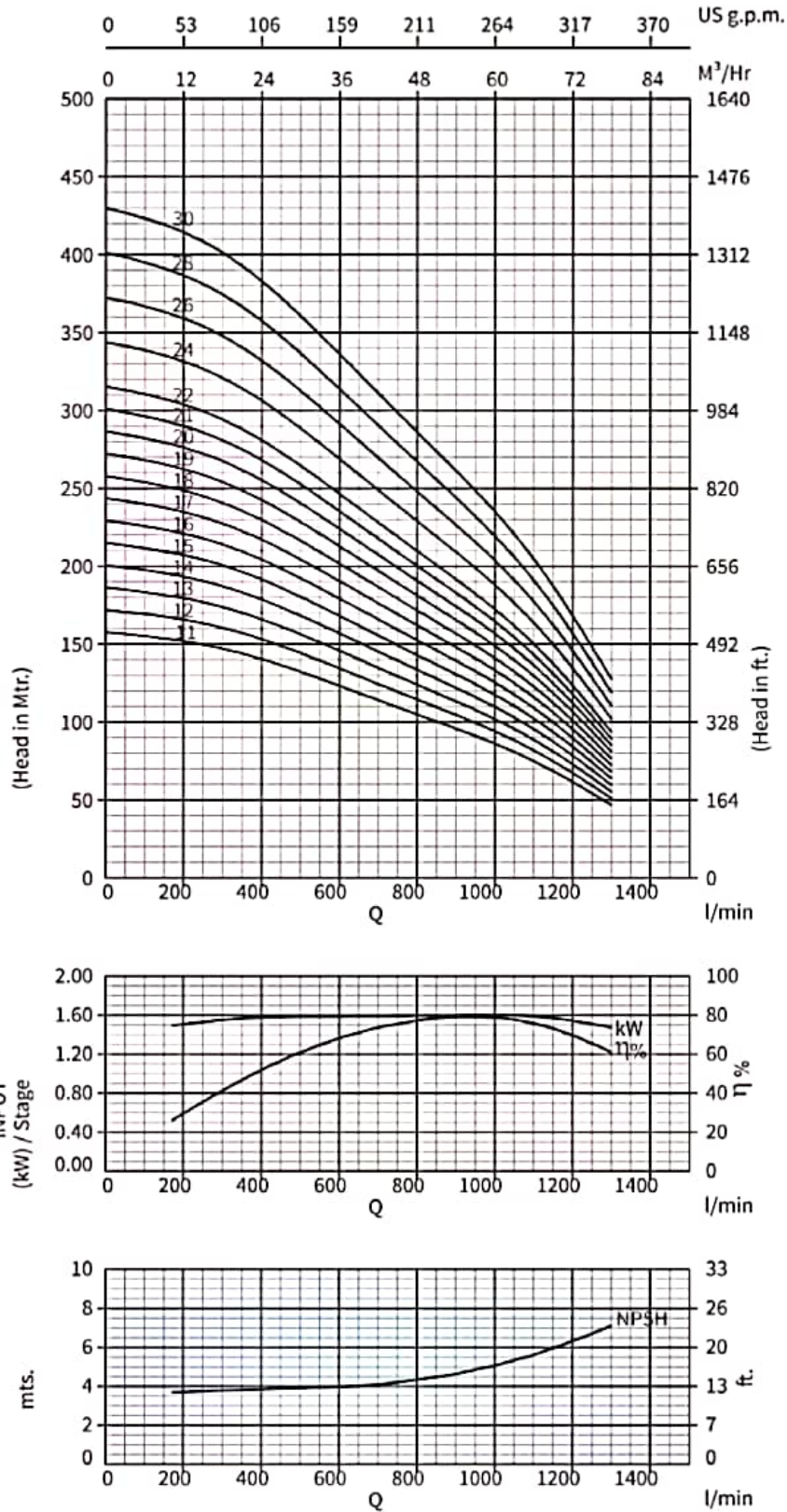

6VP 62, 50Hz
ISO 9906 Annexure A

PERFORMANCE CHART

MODEL NAME	STAGE	RATING		DISCHARGE									
		kw	HP	l/min	0	170	335	500	670	835	1000	1167	1300
THREE PHASE				m ³ /h	0	10.2	20.1	30.1	40.2	50.1	60.0	70.0	78.0

MODEL NAME	STAGE	kw	HP	HEAD IN Mtrs.	14.5	14	13	12	11	9	8	6	4
6VP 62-01	1	2.20	3.00		14.5	14	13	12	11	9	8	6	4
6VP 62-02	2	4.00	5.50		29	28	27	24	21	18	16	12	8
6VP 62-03	3	5.50	7.50		43	42	40	36	32	28	24	18	13
6VP 62-04	4	7.50	10.00		57	56	53	48	42	37	32	25	17
6VP 62-05	5	9.30	12.50		72	70	66	60	53	46	40	31	21
6VP 62-06	6	11.00	15.00		86	84	80	72	64	55	47	37	25
6VP 62-07	7	13.00	17.50		100	98	93	84	74	65	55	43	30
6VP 62-08	8	15.00	20.00		115	112	106	96	85	74	63	49	34
6VP 62-09	9	18.50	25.00		129	126	120	108	96	83	71	55	38
6VP 62-10	10	18.50	25.00		143	140	133	120	106	92	79	61	42
6VP 62-11	11	22.00	30.00		158	154	146	133	117	102	87	68	47
6VP 62-12	12	22.00	30.00		172	168	159	145	127	111	95	74	51
6VP 62-13	13	26.00	35.00		186	182	173	157	138	120	103	80	55
6VP 62-14	14	26.00	35.00		201	196	186	169	149	129	111	86	59
6VP 62-15	15	26.00	35.00		215	210	199	181	159	139	118	92	64
6VP 62-16	16	30.00	40.00		229	224	212	193	170	148	126	98	68
6VP 62-17	17	30.00	40.00		244	238	226	205	181	157	134	104	72
6VP 62-18	18	37.00	50.00		258	252	239	217	191	166	142	111	76
6VP 62-19	19	37.00	50.00		272	266	252	229	202	176	150	117	81
6VP 62-20	20	37.00	50.00		287	280	266	241	212	185	158	123	85
6VP 62-21	21	37.00	50.00		301	294	279	253	223	194	166	129	89
6VP 62-22	22	45.00	60.00		315	308	292	265	234	203	174	135	93
6VP 62-24	24	45.00	60.00		344	336	319	289	255	222	190	147	102
6VP 62-26	26	55.00	75.00		373	364	345	313	276	240	205	160	110
6VP 62-28	28	55.00	75.00		401	392	372	337	297	259	221	172	119
6VP 62-30	30	55.00	75.00		430	420	398	362	319	277	237	184	127

6VP 62, 50Hz
ISO 9906 Annexure A

Dimensions & Weights

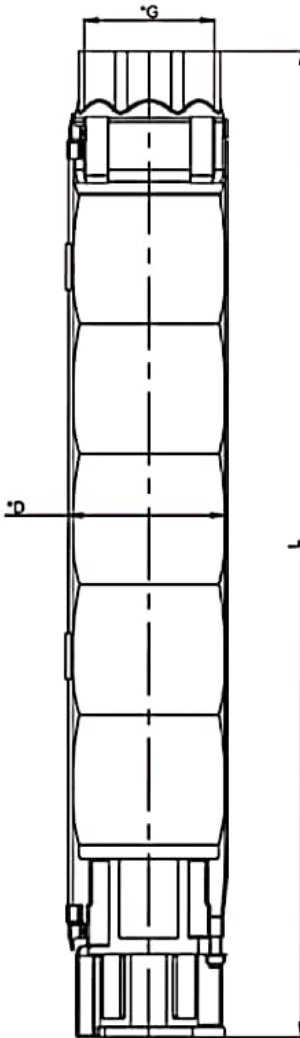

Model Name	Specification			
	*D (mm)	L (mm)	Pump Weight Kg.	Weight (Incl. pkg.) Kg.
6VP 62 - 01	147	400	10	12
6VP 62 - 02	147	513	12	14
6VP 62 - 03	147	628	14	16
6VP 62 - 04	147	741	16	18
6VP 62 - 05	147	854	18	21
6VP 62 - 06	147	967	20	23
6VP 62 - 07	147	1080	22	25
6VP 62 - 08	147	1193	24	28
6VP 62 - 09	147	1306	26	30
6VP 62 - 10	147	1424	28	32
6VP 62 - 11	147	1537	30	35
6VP 62 - 12	147	1650	32	37
6VP 62 - 13	147	1763	34	39
6VP 62 - 14	147	1876	36	41
6VP 62 - 15	147	1989	38	44
6VP 62 - 16	147	2102	40	46
6VP 62 - 17	147	2215	42	48
6VP 62 - 18	147	2328	44	51
6VP 62 - 19	147	2441	46	53
6VP 62 - 20	147	2554	48	55
6VP 62 - 21	147	2667	50	58
6VP 62 - 22	147	2780	52	60
6VP 62 - 24	147	3006	56	64

*G : Available outlet size 4" BSP

*D : With cable Guard

6VP 62 -01 to 6VP 62 -03 pumps are also available in 4" joining.

6VP 62 -22, 6VP 62 -24, 6VP 62 -26, 6VP 62 -28 & 6VP 62 -30 pumps are also available with & without mounted sleeve in 8" joining.

8VP 80 & 8VP 98 SERIES PUMP DESIGN

Material Specification

No	PART NAME	MATERIAL
1	DISCHARGE CHAMBER HOUSING	STEEL CAST 304
2	SPRING	S.S.302
3	VALVE	S.S.304
4	VALVE SEAT	N.B.R.
5	"O" RING	N.B.R.
6	VALVE SEAT HOUSING	STEEL CAST 304
7	FIRST STAGE BEARING BUSH	N.B.R. + S.S.304
8	STOP RING	S.S.304
9	SPACING WASHER	25% CFT
10	FIRST STAGE NUT	STEEL CAST 304
11	IMPELLER COLLET	S.S.304
12	BEARING BUSH STAGE	N.B.R.
13	COLLET NUT	S.S.304
14	NECKRING	N.B.R. + NYLON
15	IMC SLEEVE	S.S.304
16	INTERMEDIATE CHAMBER	S.S.304
17	IMPELLER	S.S.304
18	PUMP SHAFT (UP TO 04 STAGES)	S.S.431
18	PUMP SHAFT (05 STAGE & ABOVE)	S.S.1.4362
19	NEMA COUPLING	S.S.304
20	STRAINER	S.S.304
21	CLAMPING STRIP	S.S.304
22	HEX NUT	S.S.316
23	CABLE GUARD	S.S.304
24	SUCTION	STEEL CAST 304

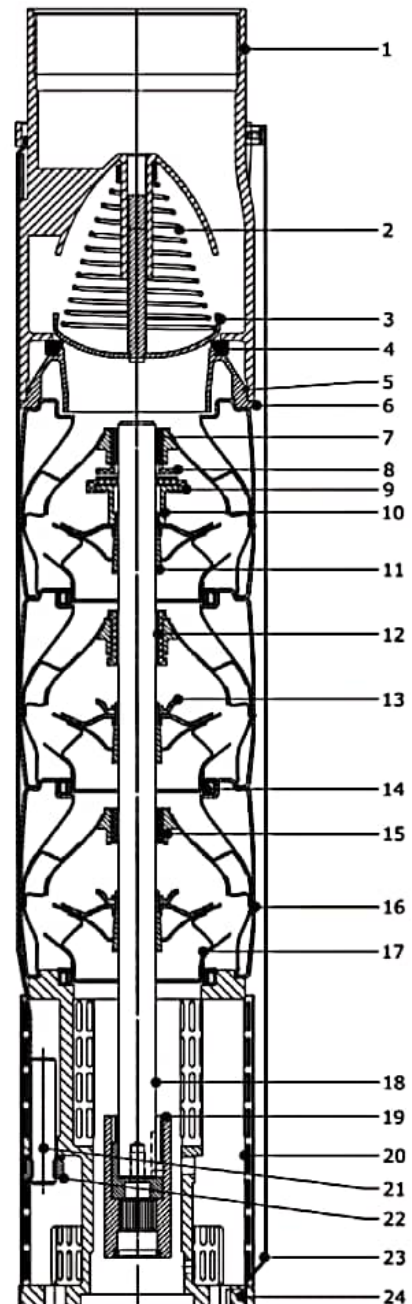

8VP 80, 50Hz
ISO 9906 Annexure A

PERFORMANCE CURVES

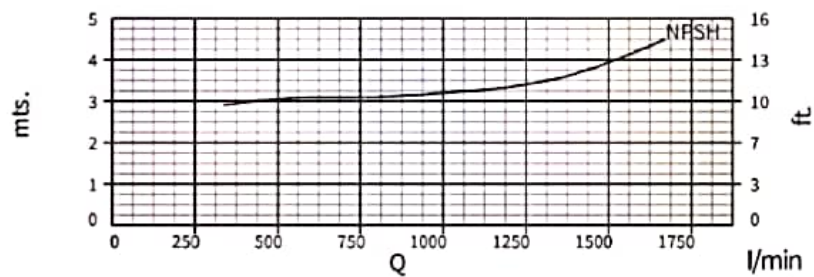
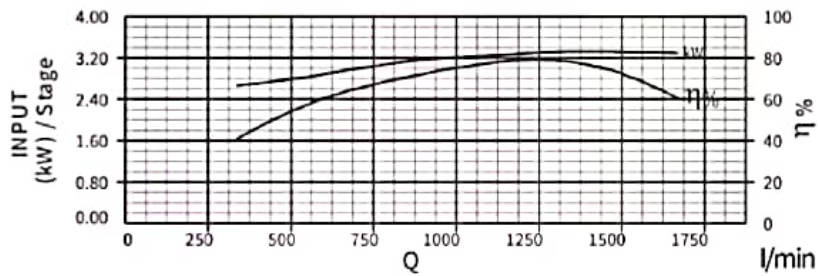
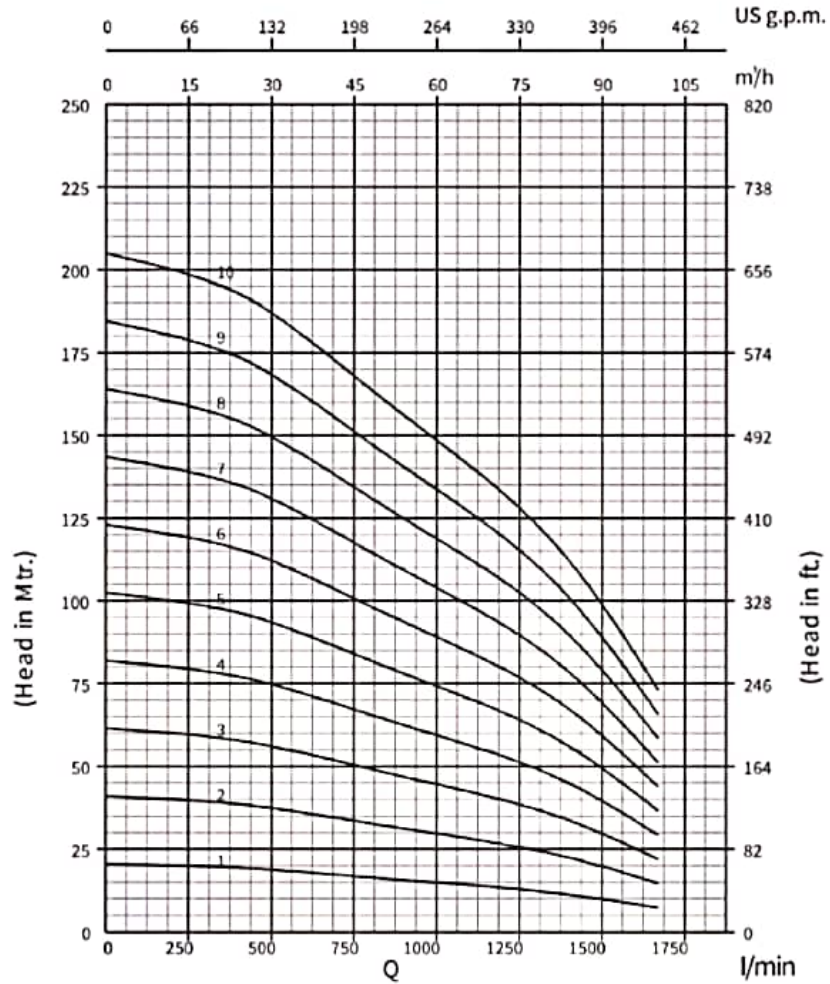

8VP 80, 50Hz
ISO 9906 Annexure A

PERFORMANCE CURVES

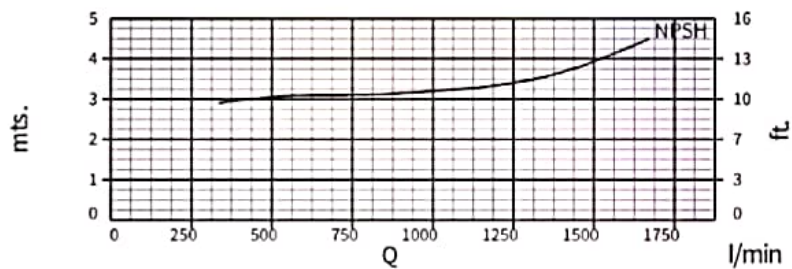
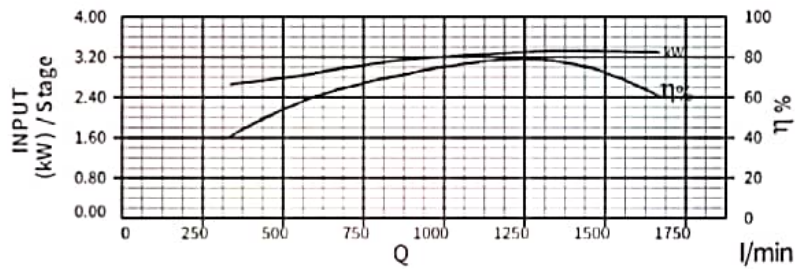
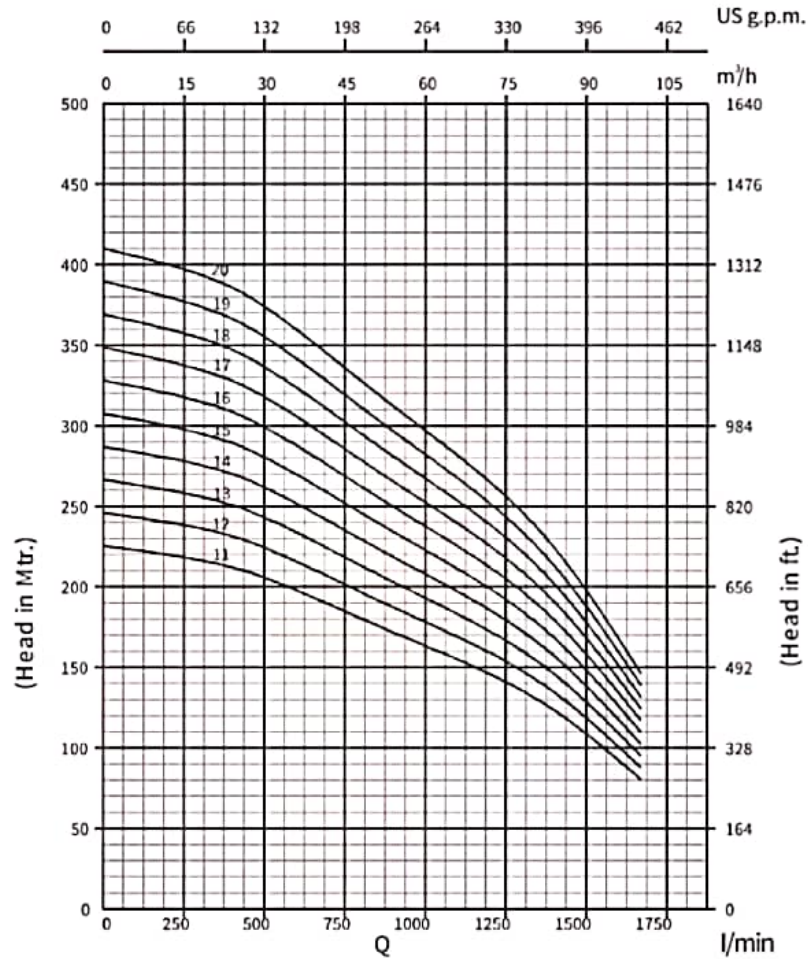

8VP 80, 50Hz
ISO 9906 Annexure A

PERFORMANCE CHART

Model Name	Stage	Rating		Discharge										
		kW	HP	l/min	0	335	500	670	835	1000	1170	1335	1500	1670
				m ³ /h	0	20.0	30.0	40.2	50.1	60.0	70.2	80.1	90.0	100.0

Model Name	Stage	kW	HP	20.5	20	19	17	16	15	14	12	10	7
8VP 80-01	1	5.50	7.50	20.5	20	19	17	16	15	14	12	10	7
8VP 80-02	2	7.50	10.00	41	40	38	35	32	30	27	24	20	15
8VP 80-03	3	11.00	15.00	62	59	56	52	48	45	41	36	30	22
8VP 80-04	4	15.00	20.00	82	79	75	70	64	59	54	48	40	29
8VP 80-05	5	18.50	25.00	102	99	94	87	80	74	68	60	50	36
8VP 80-06	6	22.00	30.00	123	118	112	105	97	89	81	72	60	44
8VP 80-07	7	26.00	35.00	144	138	131	122	113	104	95	84	70	51
8VP 80-08	8	30.00	40.00	164	158	150	140	129	119	108	96	80	58
8VP 80-09	9	30.00	40.00	184	178	169	157	145	134	122	108	90	66
8VP 80-10	10	37.00	50.00	205	198	188	174	161	148	136	120	100	73
8VP 80-11	11	37.00	50.00	226	217	206	192	177	163	149	133	110	80
8VP 80-12	12	45.00	60.00	246	237	225	209	193	178	163	145	120	88
8VP 80-13	13	55.00	75.00	266	257	244	227	209	193	176	157	130	95
8VP 80-14	14	55.00	75.00	287	276	262	244	225	208	190	169	140	102
8VP 80-15	15	55.00	75.00	308	296	281	262	242	223	203	181	150	110
8VP 80-16	16	63.00	85.00	328	316	300	279	258	238	217	193	160	117
8VP 80-17	17	63.00	85.00	348	336	319	297	274	252	230	205	170	124
8VP 80-18	18	63.00	85.00	369	356	338	314	290	267	244	217	180	131
8VP 80-19	19	75.00	100.0	390	375	356	332	306	282	257	229	190	139
8VP 80-20	20	75.00	100.0	410	395	375	349	322	297	271	241	200	146

HEAD IN Mtrs.

8VP 80, 50Hz
ISO 9906 Annexure A

Dimensions & Weights

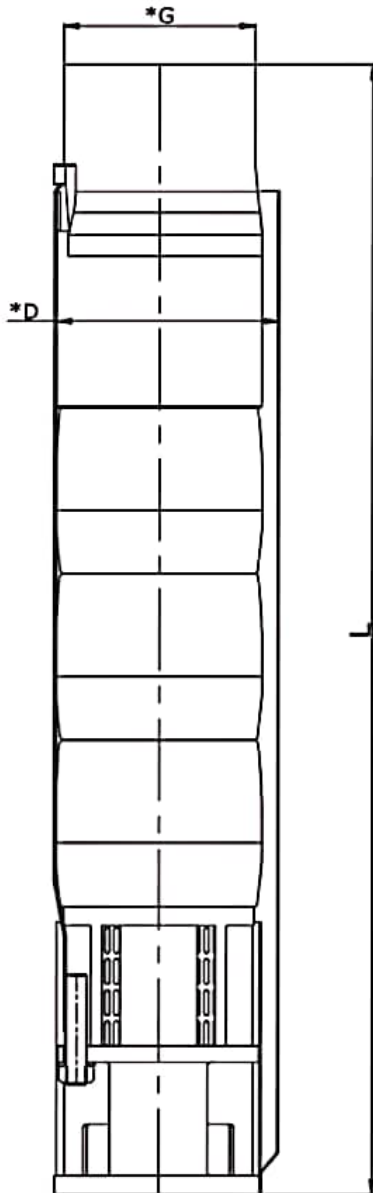

Model Name	Specification				
	D* (mm)	D** (mm)	L (mm)	Pump Weight (In Kg.)	Weight (Incl. pkg.) Kg.
8VP 80 - 01	175	180	620	21	23
8VP 80 - 02	175	180	748	25	28
8VP 80 - 03	175	180	876	29	32
8VP 80 - 04	175	180	1004	33	36
8VP 80 - 05	175	180	1132	37	41
8VP 80 - 06	175	180	1260	41	45
8VP 80 - 07	175	180	1388	45	50
8VP 80 - 08	175	180	1516	49	54
8VP 80 - 09	175	180	1644	53	58
8VP 80 - 10	175	180	1772	55	63
8VP 80 - 11	175	180	1900	59	67
8VP 80 - 12	196	200	2028	63	72
8VP 80 - 13	196	200	2156	67	76
8VP 80 - 14	196	200	2284	71	80
8VP 80 - 15	196	200	2412	75	85
*8VP 80 - 17	196	200	2668	83	87
*8VP 80 - 18	196	200	2796	87	94
8VP 80 - 19	196	200	2924	91	98
8VP 80 - 20	196	200	3052	95	102

* G: Available Outlet Size 5" BSP

* D: Maximum Diameter With Single Cable Guard

** D: Maximum Diameter With Double Cable Guard upto 50 HP 6" Motor Joining.

8VP 80 -01 to 8VP 80 -11 pump are available in 6" joining.
8VP 80 -12 to 8VP 80 -20 pump are available in 8" joining.

8VP 98, 50Hz
ISO 9906 Annexure A

PERFORMANCE CURVES

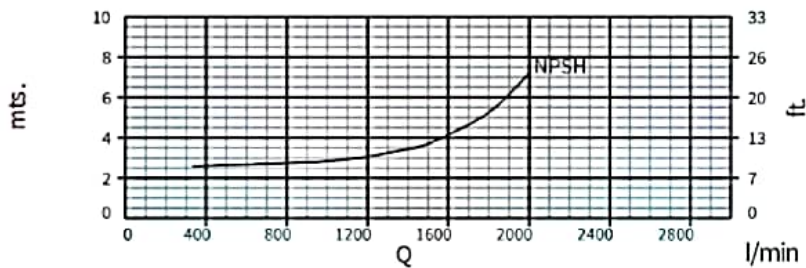
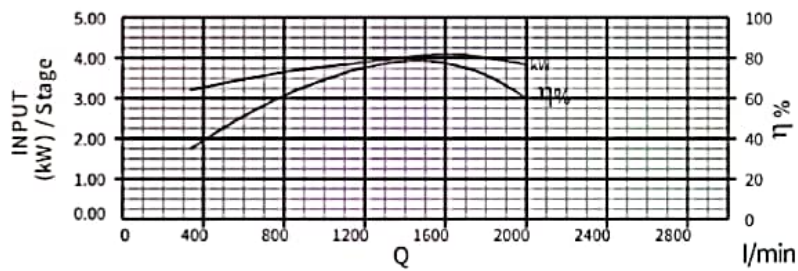
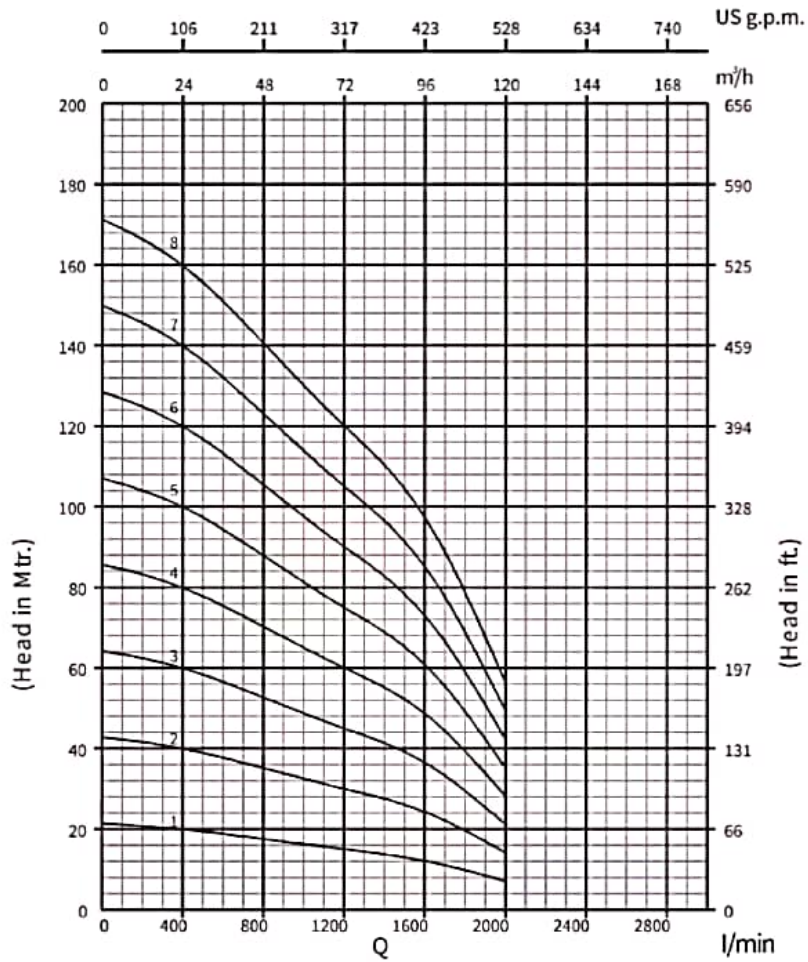

8VP 98, 50Hz
ISO 9906 Annexure A

PERFORMANCE CURVES

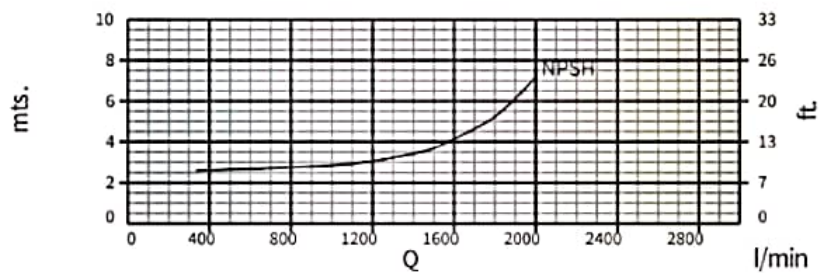
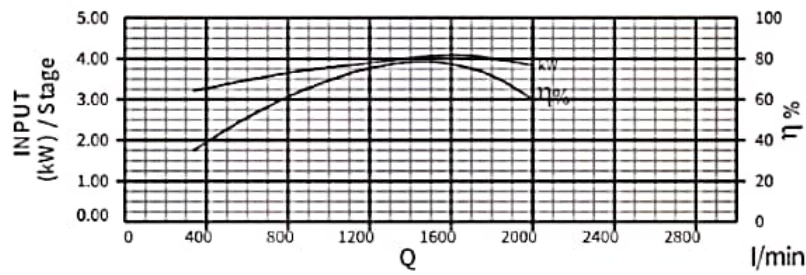
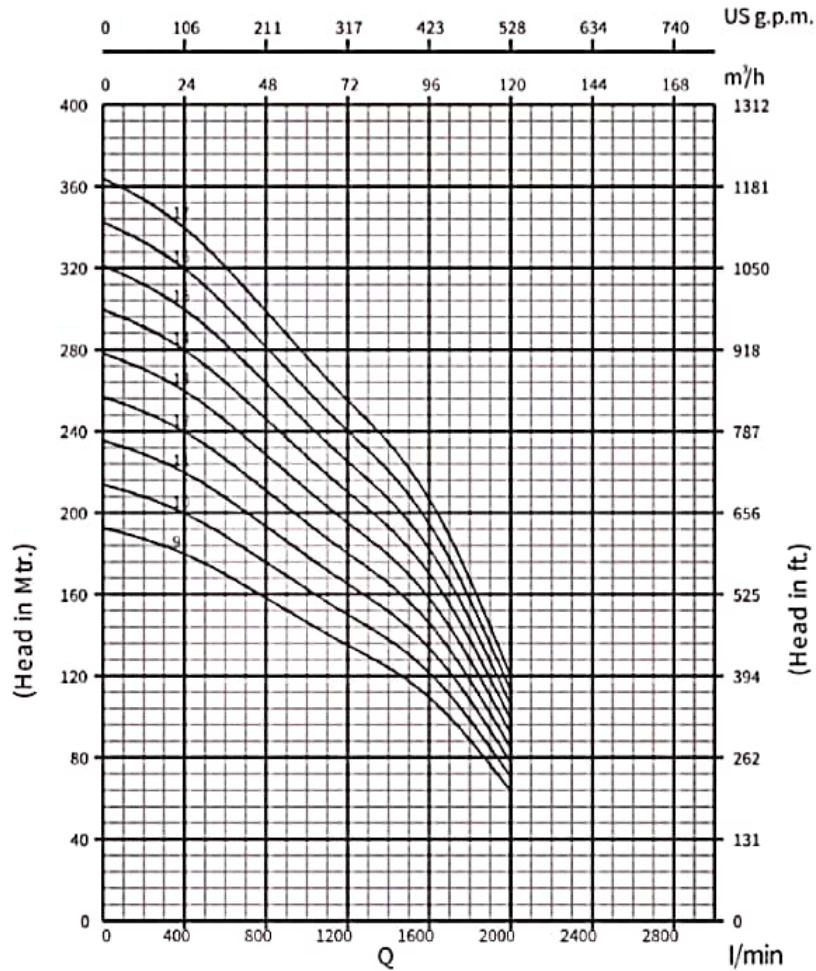

8VP 98, 50Hz
ISO 9906 Annexure A

PERFORMANCE CHART

Model Name	Three Phase	Stage	Rating		Discharge										
			kW	HP	l/min	0	335	675	1010	1170	1335	1500	1670	1835	2000
					m ³ /h	0	20.0	40.5	60.6	70.2	80.1	90.0	100.2	110.1	120.0

Model Name	Stage	kW	HP	HEAD IN Mtrs.	21.5	21	18	16	15	14	13	12	9	7	
8VP 98-01	1	5.50	7.50		43	41	37	32	30	28	26	23	19	14	
8VP 98-02	2	9.30	12.50		64	62	55	49	46	43	39	35	28	21	
8VP 98-03	3	13.00	17.50		86	82	74	65	61	57	52	46	38	28	
8VP 98-04	4	18.50	25.00		107	103	92	81	76	71	66	58	47	35	
8VP 98-05	5	22.00	30.00		128	123	110	97	91	85	79	69	56	42	
8VP 98-06	6	26.00	35.00		150	144	129	113	106	100	92	81	66	49	
8VP 98-07	7	30.00	40.00		171	164	147	129	121	114	105	92	75	56	
8VP 98-08	8	37.00	50.00		193	185	166	146	137	128	118	104	85	63	
8VP 98-09	9	37.00	50.00		214	205	184	162	152	142	131	115	94	70	
8VP 98-10	10	45.00	60.00		235	226	203	178	167	157	144	127	104	78	
8VP 98-11	11	55.00	75.00		257	246	221	194	182	171	157	138	113	85	
8VP 98-12	12	55.00	75.00		278	267	239	210	197	185	171	150	122	92	
8VP 98-13	13	55.00	75.00		300	287	258	227	212	199	184	161	132	99	
8VP 98-14	14	63.00	85.00		321	308	276	243	228	213	197	173	141	106	
8VP 98-15	15	75.00	100.0		342	328	295	259	243	228	210	184	151	113	
8VP 98-16	16	75.00	100.0		364	349	313	275	258	242	223	196	160	120	
8VP 98-17	17	75.00	100.0												

8VP 98, 50Hz
ISO 9906 Annexure A

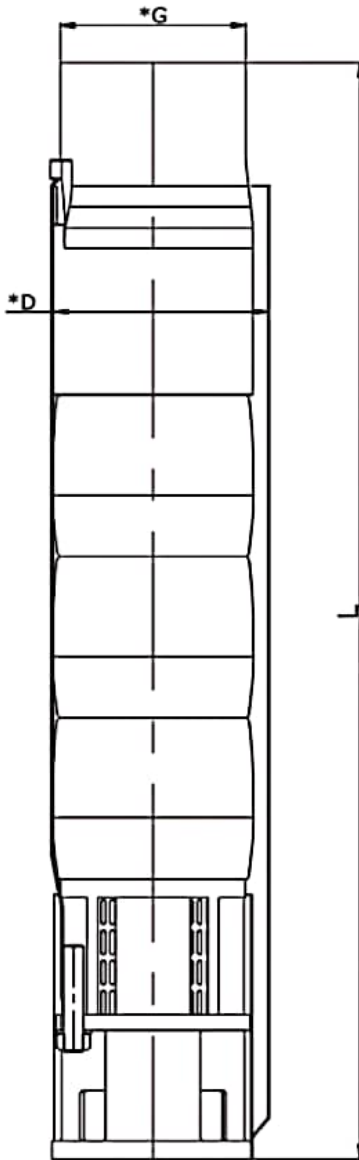

Dimensions & Weights

Model Name	Specification				
	D* (mm)	D** (mm)	L (mm)	Pump Weight (in Kg.)	Weight (Incl. pkg.) Kg.
8VP 98 - 01	175	180	620	21	23
8VP 98 - 02	175	180	748	25	28
8VP 98 - 03	175	180	876	29	32
8VP 98 - 04	175	180	1004	33	36
8VP 98 - 05	175	180	1132	37	41
8VP 98 - 06	175	180	1260	41	45
8VP 98 - 07	175	180	1388	45	50
8VP 98 - 08	175	180	1516	49	54
8VP 98 - 09	175	180	1644	53	58
8VP 98 - 10	196	200	1772	55	63
8VP 98 - 11	196	200	1900	59	67
8VP 98 - 12	196	200	2028	63	72
8VP 98 - 13	196	200	2156	67	76
8VP 98 - 14	196	200	2284	71	80
8VP 98 - 15	196	200	2412	75	85
8VP 98 - 16	196	200	2540	79	89
8VP 98 - 17	196	200	2668	83	87

* G: Available Outlet Size 5" BSP

* D: Maximum Diameter With Single Cable Guard

** D: Maximum Diameter With Double Cable Guard upto 50 HP 6" Motor Joining.

8VP 98 -01 to 8VP 98 -09 pump are available in 6" joining.
8VP 98 -10 to 8VP 98 -17 pump are available in 8" joining.

10VP 128 SERIES PUMP DESIGN

Material Specification

NO	PART NAME	MATERIAL	STANDARD
1	BOWL / DIFFUSER	STAINLESS STEEL	304
2	IMPELLER	STAINLESS STEEL	304
3	NECK RING	NBR	
4	SHAFT	STAINLESS STEEL	431
5	COUPLE	STAINLESS STEEL	316
6	DELIVERY CASING	STAINLESS STEEL	304
7	SUCTION CASE	STAINLESS STEEL	304
8	BEARING BUSH	NBR	
9	STRAINER	STAINLESS STEEL	304

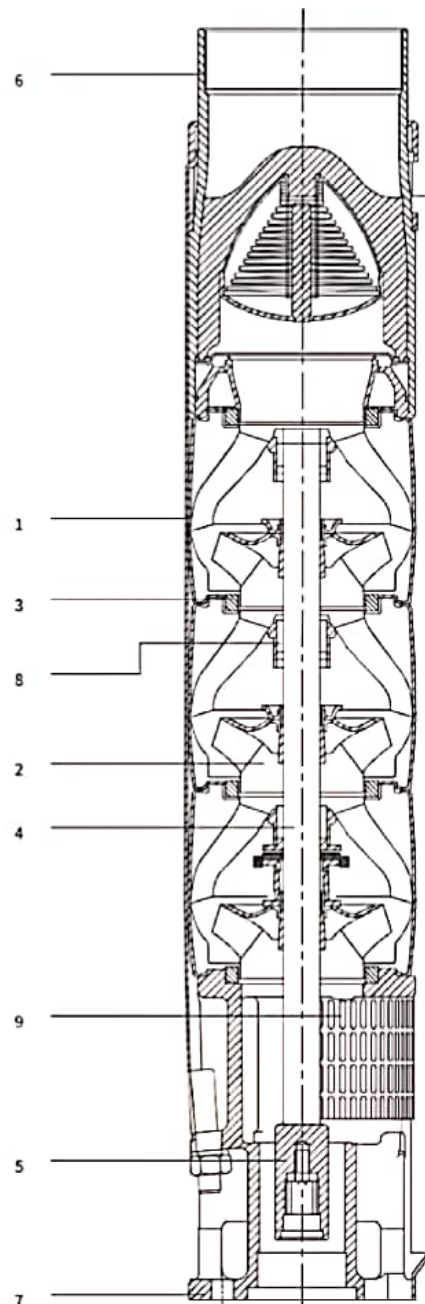

10VP 128, 50Hz
ISO 9906 Annexure A

PERFORMANCE CURVES

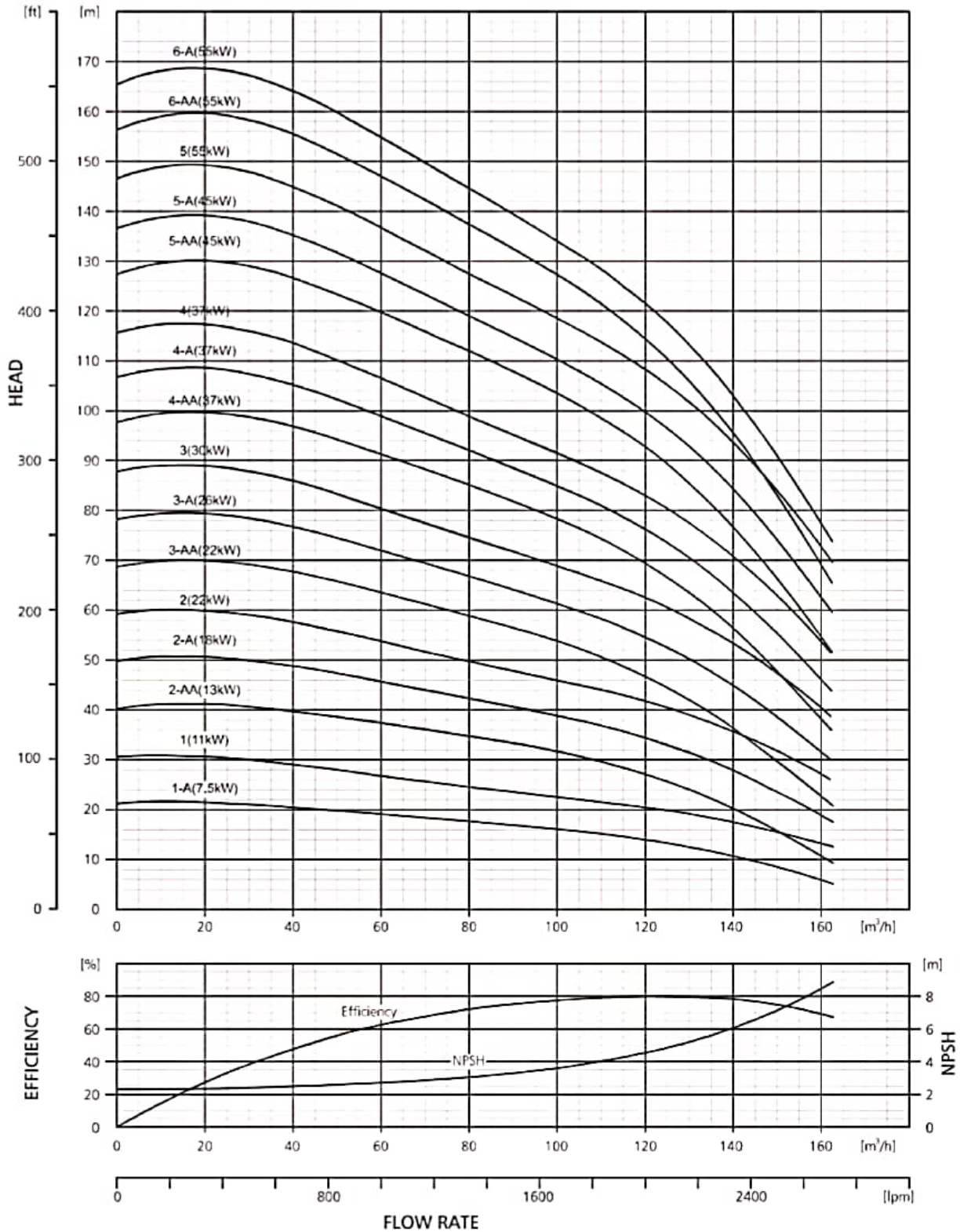

10VP 128, 50Hz
ISO 9906 Annexure A

PERFORMANCE CURVES

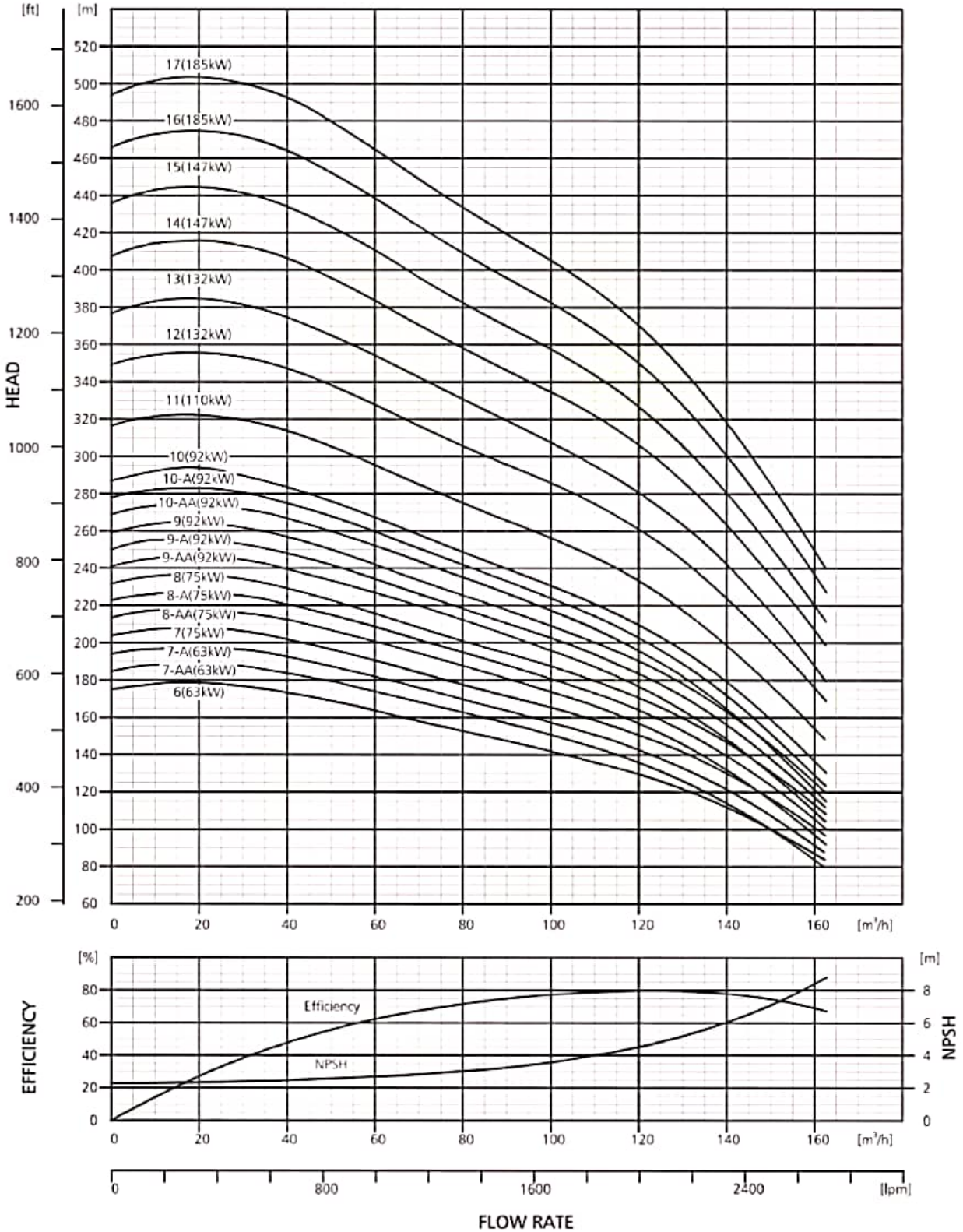

10VP 128, 50Hz
ISO 9906 Annexure A

PERFORMANCE CHART

Model Name	Rating		Discharge													
	kW	HP	l/min	0	1000	1167	1333	1500	1667	1833	2000	2167	2333	2500	2667	2700
m ³ /h			0	60	70	80	90	100	110	120	130	140	150	160	162	

Model Name	kW	HP	HEAD IN Mtrs.													
10VP-128-1-A	7.5	10	21	19	18	17	17	16	15	14	12	10	8	6	5	
10VP-128-1	11	15	30	27	25	24	23	22	21	20	19	17	15	13	12	
10VP-128-2-AA	13	17.5	40	37	36	35	33	31	29	27	24	20	16	11	10	
10VP-128-2-A	18.5	25	50	45	44	42	40	39	37	34	31	28	23	19	18	
10VP-128-2	22	30	59	54	52	50	48	46	44	42	39	35	32	27	26	
10VP-128-3-AA	22	30	69	63	61	59	56	54	50	47	42	36	30	22	21	
10VP-128-3-A	26	35	78	72	69	67	64	61	58	54	50	45	38	31	30	
10VP-128-3	30	40	88	80	77	74	72	69	66	62	58	53	47	40	39	
10VP-128-4-AA	37	50	98	91	88	85	82	78	74	69	63	56	48	38	36	
10VP-128-4-A	37	50	107	99	95	92	88	85	81	76	70	63	55	46	44	
10VP-128-4	37	50	116	106	102	99	95	91	87	83	77	71	63	54	52	
10VP-128-5-AA	45	60	127	120	116	112	108	103	98	93	85	77	66	54	52	
10VP-128-5-A	45	60	136	127	123	119	115	110	105	100	93	84	74	63	60	
10VP-128-5	55	75	146	137	132	127	123	118	114	108	102	93	84	72	70	
10VP-128-6-AA	55	75	156	147	142	137	132	127	121	114	106	95	83	69	66	
10VP-128-6-A	55	75	165	155	150	144	139	134	128	121	113	103	91	77	74	
10VP-128-6	63	85	175	164	158	153	147	142	136	130	122	112	100	87	84	
10VP-128-7-AA	63	85	185	174	168	163	157	151	144	136	126	114	100	83	80	
10VP-128-7-A	63	85	194	182	176	170	164	158	151	143	133	122	107	92	88	
10VP-128-7	75	100	204	191	184	178	172	165	159	151	142	130	117	101	97	
10VP-128-8-AA	75	100	214	201	194	188	181	174	166	157	146	132	116	97	93	
10VP-128-8-A	75	100	223	209	202	195	188	181	173	164	153	139	123	105	101	
10VP-128-8	75	100	232	216	209	202	195	188	180	171	160	147	131	113	109	
10VP-128-9-AA	93	125	241	227	219	212	204	196	187	177	164	149	130	110	105	
10VP-128-9-A	93	125	250	234	226	219	211	203	194	184	171	156	138	117	113	
10VP-128-9	93	125	260	242	234	226	218	209	201	191	178	163	146	125	121	
10VP-128-10-AA	93	125	269	252	244	235	227	218	208	196	182	165	144	121	117	
10VP-128-10-A	93	125	278	260	251	242	233	224	214	203	189	172	152	129	124	
10VP-128-10	93	125	287	267	258	249	240	231	221	210	196	179	159	137	132	

10VP 162 SERIES PUMP DESIGN

Material Specification

NO	PART NAME	MATERIAL	STANDARD
1	BOWL / DIFFUSER	STAINLESS STEEL	304
2	IMPELLER	STAINLESS STEEL	304
3	NECK RING	NBR	
4	SHAFT	STAINLESS STEEL	431
5	COUPLE	STAINLESS STEEL	316
6	DELIVERY CASING	STAINLESS STEEL <td 304	
7	SUCTION CASE	STAINLESS STEEL	304
8	BEARING BUSH	NBR	
9	STRAINER	STAINLESS STEEL	304

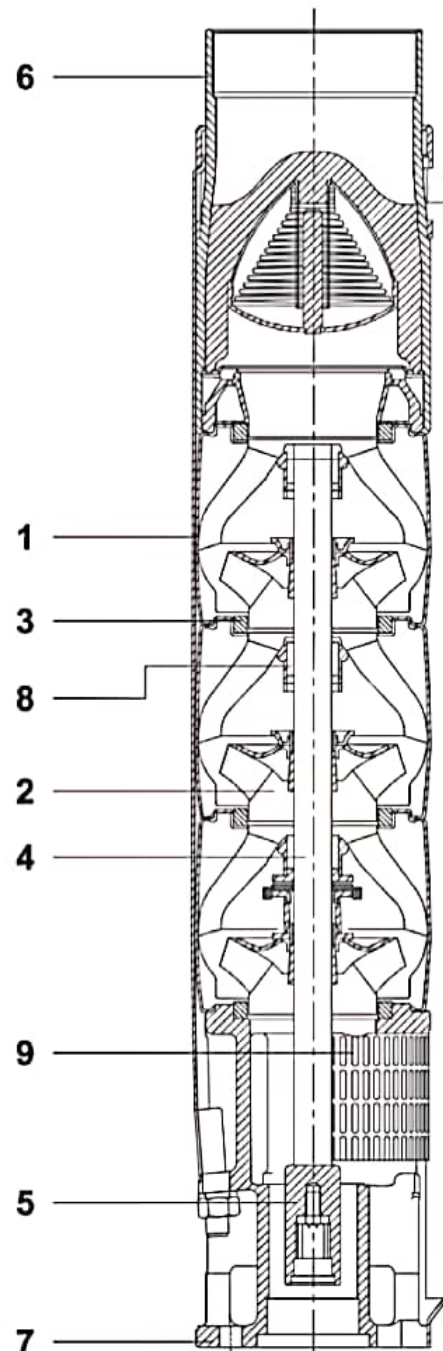

10VP 162, 50Hz
ISO 9906 Annexure A

PERFORMANCE CURVES

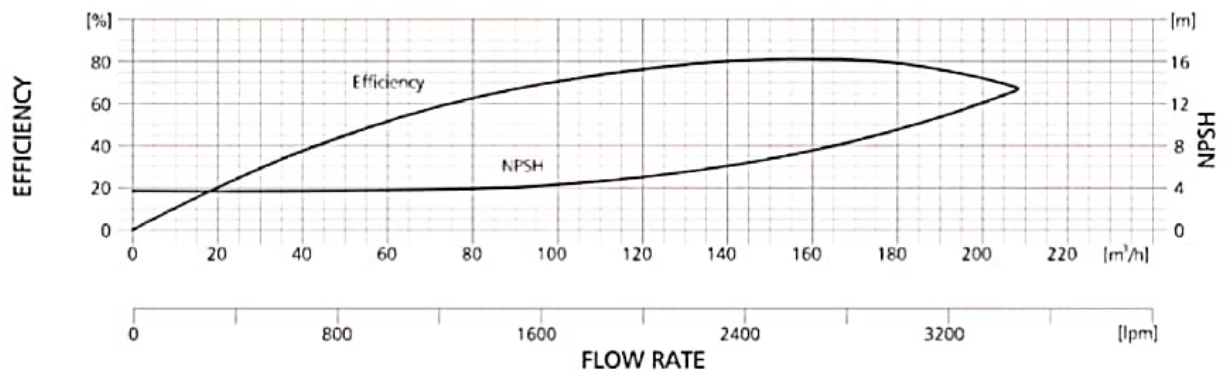
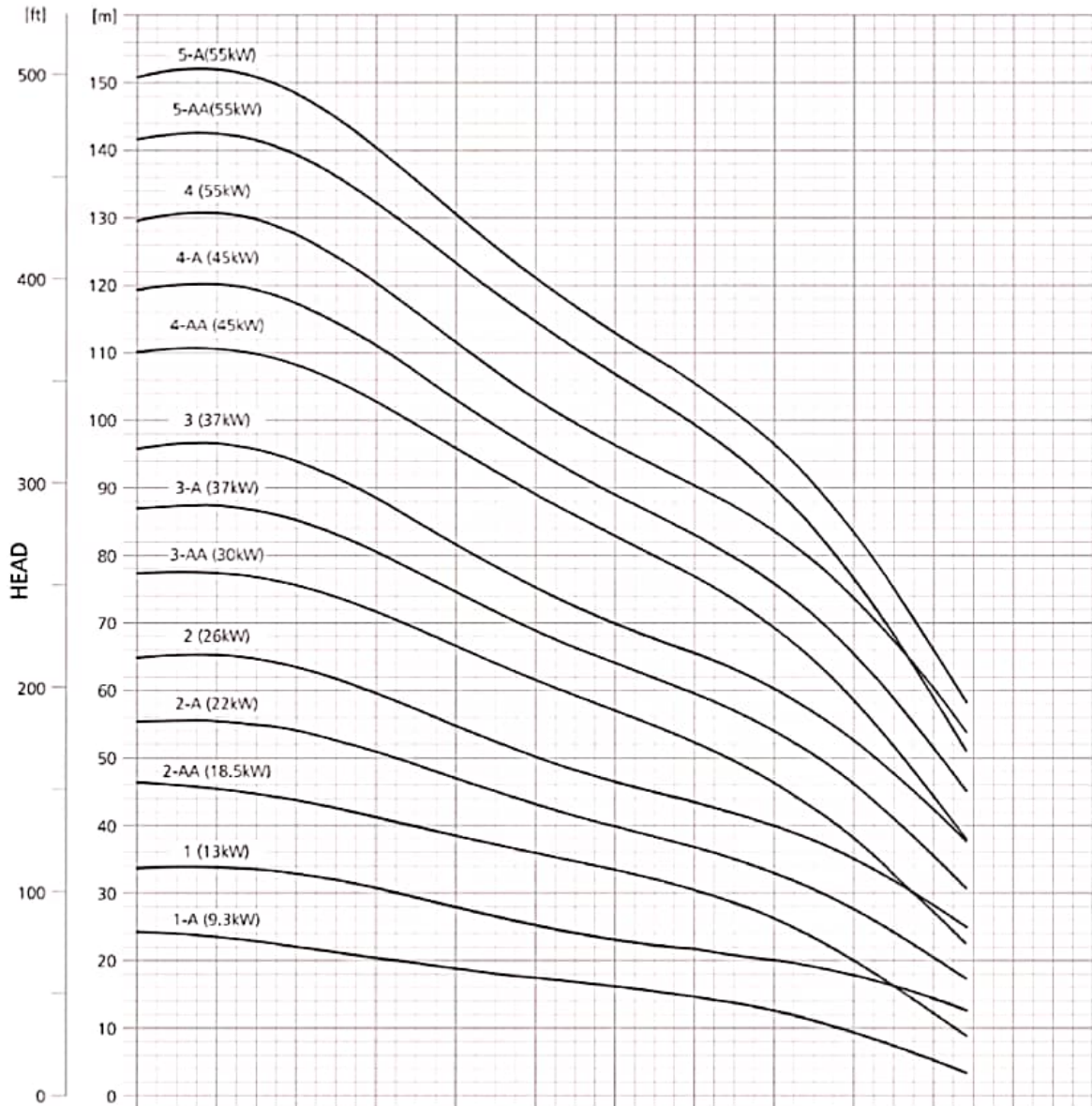

10VP 162, 50Hz
ISO 9906 Annexure A

PERFORMANCE CHART

Model Name	Rating		l/min	Discharge														
	kW	HP		0	1333	1500	1667	1833	2000	2167	2333	2500	2667	2833	3000	3167	3333	3467
Three Phase			m ³ /h	0	80	90	100	110	120	130	140	150	160	170	180	190	200	208

Model Name	Rating kW	Rating HP	HEAD IN Mtrs.	24	19	18	17	17	16	15	15	14	13	11	9	7	5	3
10VP-162-1-A	9.3	12.50		24	19	18	17	17	16	15	15	14	13	11	9	7	5	3
10VP-162-1	13.00	17.50		34	28	26	25	24	23	22	22	21	20	19	18	16	14	13
10VP-162-2-AA	18.50	25.00		46	38	37	36	35	33	32	30	29	26	23	20	16	12	9
10VP-162-2-A	22.00	30.00		55	47	45	43	41	40	38	37	35	33	31	28	24	20	17
10VP-162-2	26.00	35.00		65	55	52	50	48	46	45	43	42	40	38	35	32	28	25
10VP-162-3-AA	30.00	40.00		77	67	64	62	59	57	55	52	49	46	42	38	33	27	23
10VP-162-3-A	37.00	50.00		87	75	72	69	66	64	62	59	57	54	50	46	41	35	31
10VP-162-3	37.00	50.00		96	82	78	75	72	70	68	65	63	60	57	53	48	42	38
10VP-162-4-AA	45.00	60.00		110	96	92	89	86	83	80	77	73	69	64	58	52	44	38
10VP-162-4-A	45.00	60.00		119	103	99	95	92	89	86	83	80	76	71	65	59	51	45
10VP-162-4	55.00	75.00		129	111	107	103	100	96	93	90	87	83	79	74	67	60	54
10VP-162-5-AA	55.00	75.00		142	123	119	114	111	107	103	99	95	90	84	76	68	59	51
10VP-162-5-A	55.00	75.00		151	130	126	121	117	113	109	105	101	96	90	83	75	66	58

10VP 162, 50Hz
ISO 9906 Annexure A

PERFORMANCE CURVES

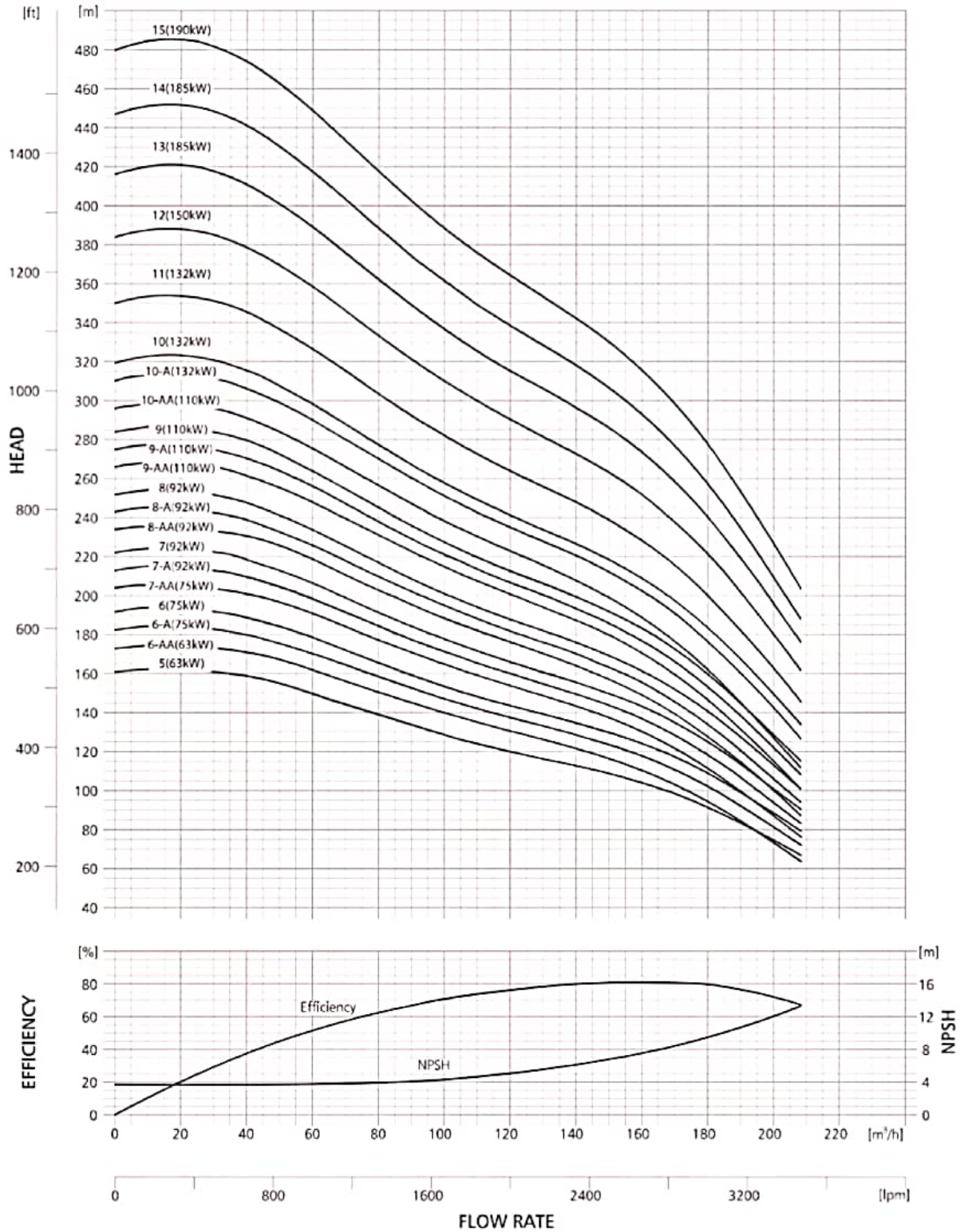

10VP 162, 50Hz
ISO 9906 Annexure A

PERFORMANCE CHART

Model Name	Rating		Discharge															
	kW	HP	l/min	0	1333	1500	1667	1833	2000	2167	2333	2500	2667	2833	3000	3167	3333	3467
Three Phase					m ³ /h	0	80	90	100	110	120	130	140	150	160	170	180	190

Model Name	Rating kW	Rating HP	HEAD IN Mtrs.	161	139	133	129	124	120	116	113	109	104	98	91	83	74	67
10VP-162-5	63.00	85.00		173	150	145	140	135	131	126	121	116	110	103	94	84	73	64
10VP-162-6-AA	63.00	85.00		183	158	153	147	142	137	133	128	123	118	111	102	92	81	72
10VP-162-6-A	75.00	100.00		192	166	159	154	148	144	139	135	130	124	117	109	99	88	79
10VP-162-6	75.00	100.00		204	177	171	165	159	154	149	143	137	130	122	112	100	87	76
10VP-162-7-AA	75.00	100.00		213	184	177	171	165	160	155	149	144	137	128	118	107	94	84
10VP-162-7-A	92.00	125.00		222	191	184	177	171	166	161	155	150	143	135	125	113	101	91
10VP-162-7	92.00	125.00		234	203	195	188	182	176	170	164	157	149	139	127	114	99	87
10VP-162-8-AA	92.00	125.00		243	210	202	195	188	182	176	170	163	155	145	134	121	106	94
10VP-162-8-A	92.00	125.00		252	217	208	201	194	188	182	176	169	161	152	140	127	113	101
10VP-162-8	92.00	125.00		266	231	223	215	207	201	194	187	179	170	159	146	131	115	102
10VP-162-9-AA	110.00	150.00		275	238	229	221	214	207	200	193	186	177	166	153	138	122	109
10VP-162-9-A	110.00	150.00		284	245	236	227	220	213	206	199	192	183	172	160	145	129	116
10VP-162-9	110.00	150.00																

10VP 162, 50Hz
ISO 9906 Annexure A

PERFORMANCE CURVES

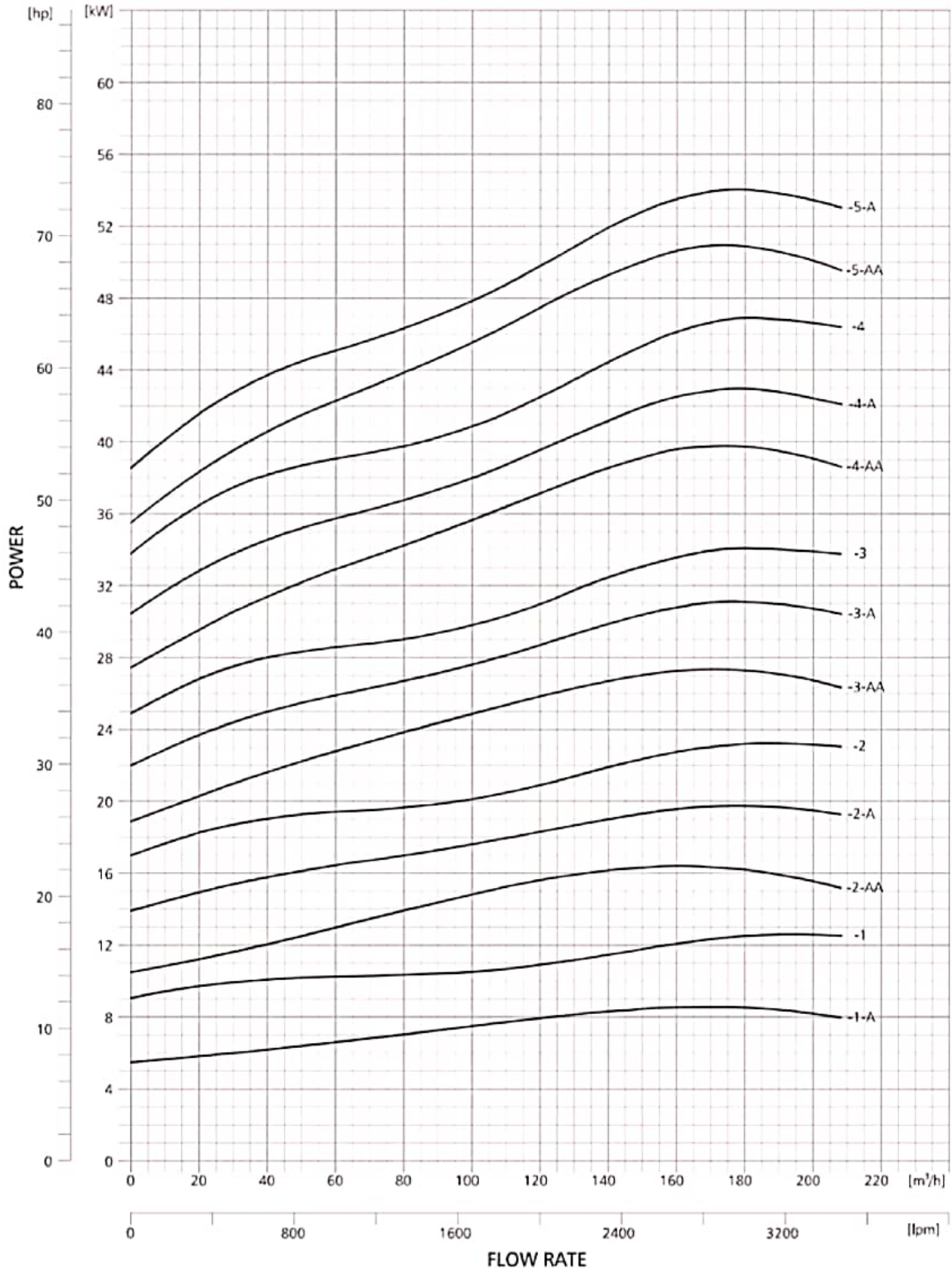

10VP 162, 50Hz
ISO 9906 Annexure A

PERFORMANCE CURVES

